

Drawing No.  
**P 2717**  
 Sheet 1 of 2

Related Drawings  
 P 2713 & S 41

© CROWN COPYRIGHT

- NOTES:—
1. The legend is from the Transport Medium alphabet at the x-height shown.
  2. Details of the telephone symbol are given on S 41 (Tile A).
  3. The tile outlines do not form part of the sign.
  4. COLOURS : As indicated.
  5. Elevation B is shown on sheet 2.

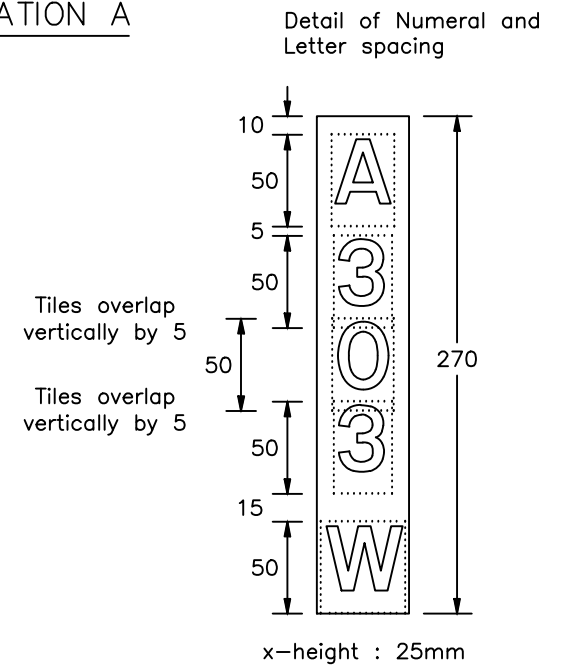
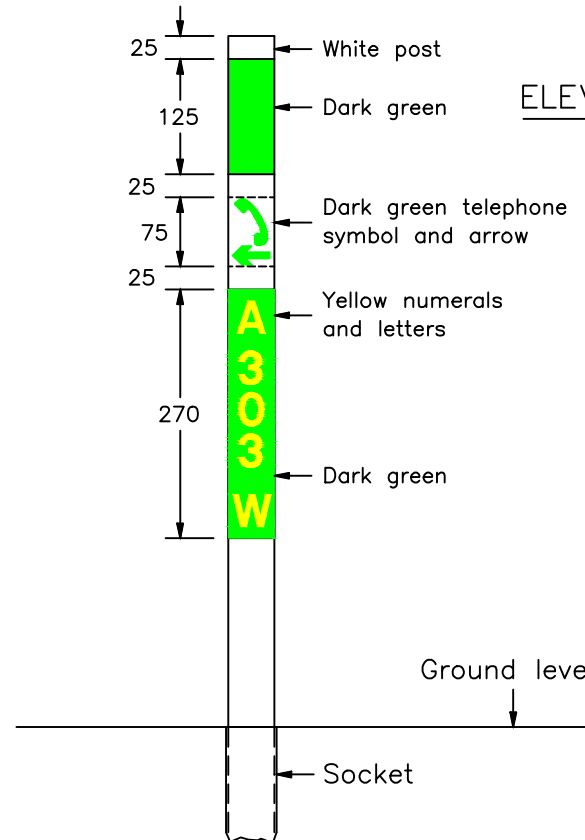
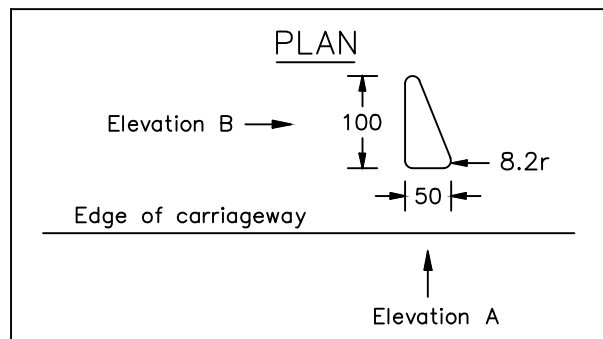
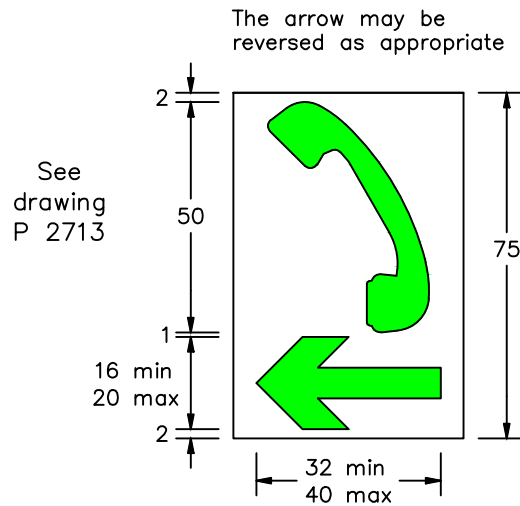

P2717-1

Before using this drawing, confirm that it has not been superseded.

Department for  
**Transport**

Title: Emergency Sign  
 PRIMARY ROUTE MARKER POST

Issue: Date:  
 A: 2.11.04  
 B: 11.1.11  
 C:

Drawn by : L.W.  
 Approved by : R.M.

Dimensions :  
 MILLIMETRES

Drawing No.  
**P 2717**  
 Sheet 1 of 2

Drawing No.  
**P 2717**  
 Sheet 2 of 2

Before using this drawing, confirm that it has not been superseded.

© CROWN COPYRIGHT

- NOTES:— 1. The legend is from the Transport Medium alphabet at the x-height shown.  
 2. The tile outlines do not form part of the sign.  
 3. COLOURS : As indicated.  
 4. Elevation A is shown on sheet 1.

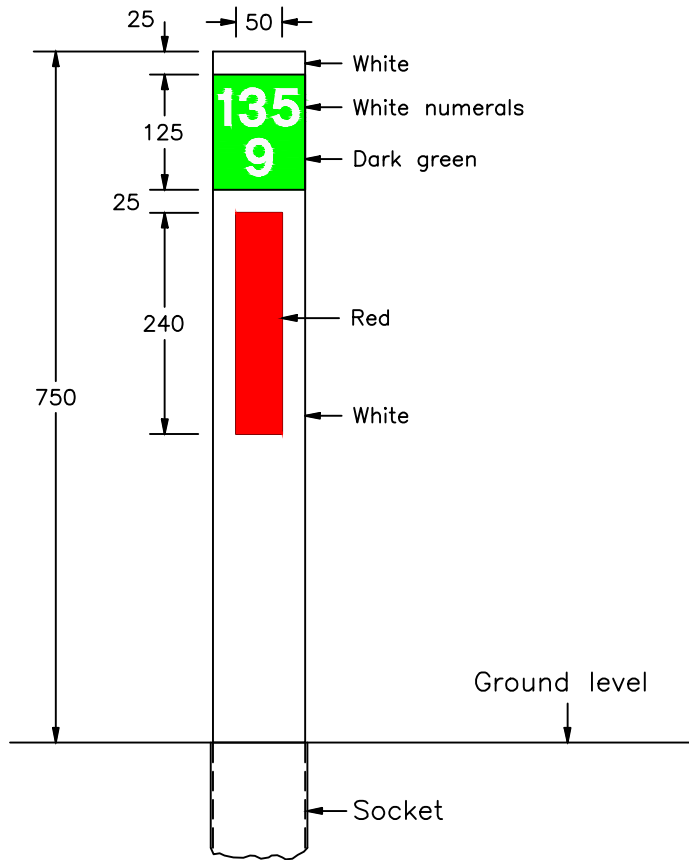

ELEVATION B

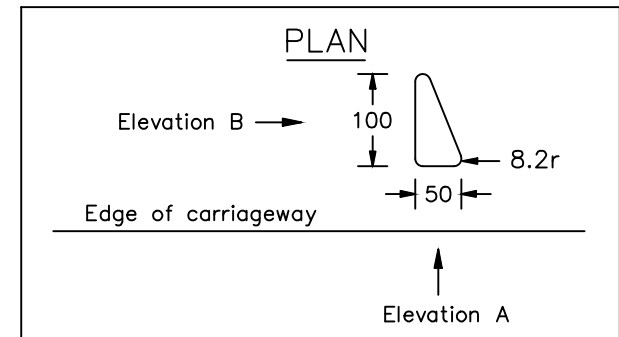
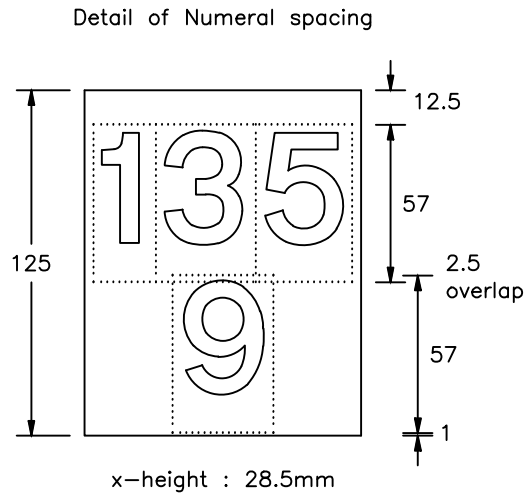

P2717-2

Department for  
**Transport**

Title: Emergency Sign  
 PRIMARY ROUTE MARKER POST

Issue: Date:  
 A: 2.11.04  
 B: 11.11.11  
 C:

Drawn by : L.W.  
 Approved by: R.M.

Dimensions :  
 MILLIMETRES

Drawing No.  
**P 2717**  
 Sheet 2 of 2