

Drawing No.
P 557.4

Before using this drawing, confirm that it has not been superseded.

© CROWN COPYRIGHT

- NOTES:— 1. The legend is from the Transport Heavy alphabet at the x-heights shown.
2. The tile outlines do not form part of the signs.
3. COLOURS : Background ----- WHITE
Legend, Arrow & Border ---- BLACK
4. DIMENSIONS : x-heights are in millimetres, other dimensions are in stroke widths. (4sw = x-height)

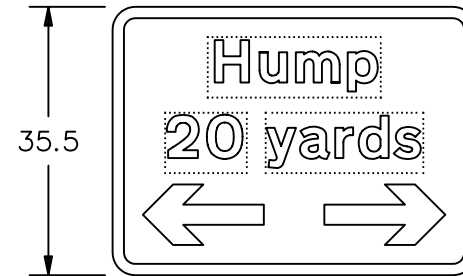
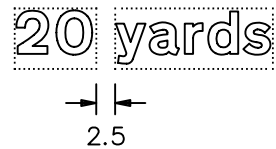
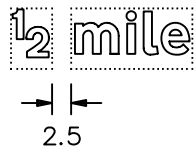
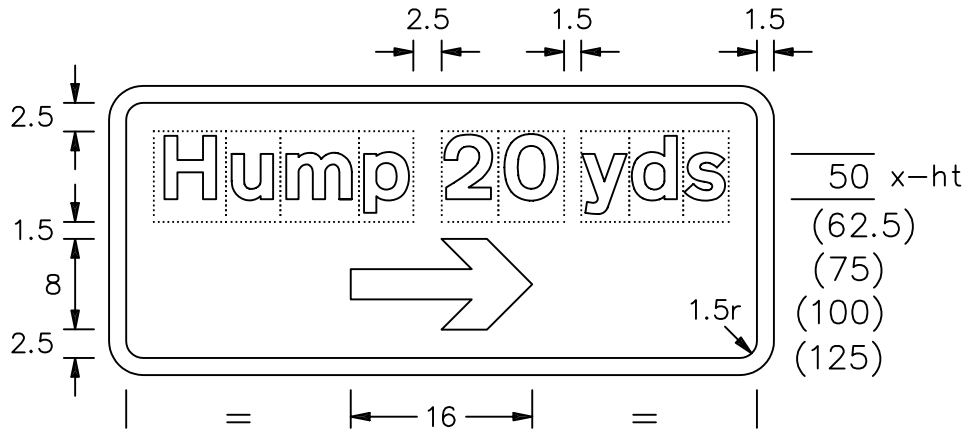

VARIANT

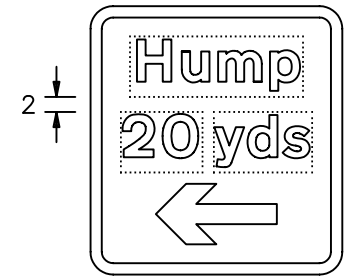

VARIANT

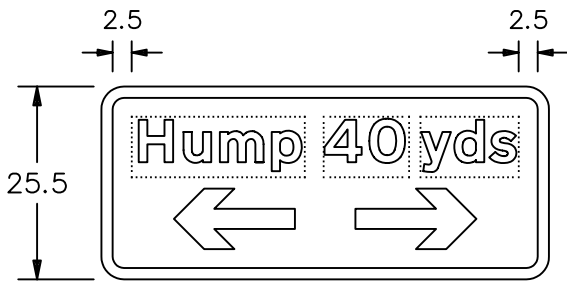

VARIANT

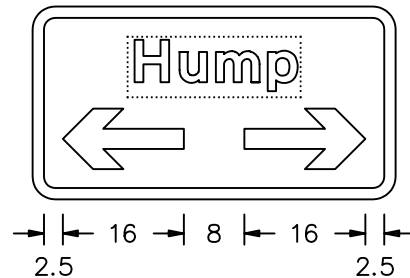

VARIANT

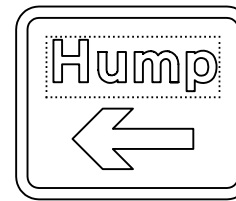

VARIANT



VARIANT

(x-height shall be 50mm when the arrow is omitted)

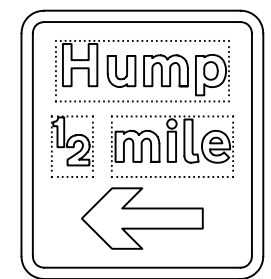

VARIANT

P557x4

Department for
Transport

Title: Warning Signs
SUPPLEMENTARY PLATES
FOR USE WITH P 557.1

Issue: Date:
A: 28.6.94
B: 13.11.02
C:

Drawn by:
R.M.
Approved by:
R.M.

Dimensions:
SEE
NOTE 4

Drawing No.
P 557.4