



**ROAD TRAFFIC REGULATION ACT 1984 – SECTIONS 64 AND 65
AUTHORISATION OF TRAFFIC SIGNS AND SPECIAL DIRECTIONS**

The Secretary of State for Transport, in exercise of her powers under sections 64 and 65 of the Road Traffic Regulation Act 1984, and of all other powers enabling her in that behalf, for the purpose of informing road users of restrictions, requirements or prohibitions and information at appropriate sites on roads for which Manchester City Council is the traffic authority, hereby:-

Bus stop clearway and taxi ranks at different times of the day

1. authorises the erection at the said sites on the said roads of a traffic sign (hereinafter referred to as “the Authorised Sign A”) conforming as to size, colour and character with that referenced “Authorised Sign A” in the attached set of drawings numbered GT50/100/0007-1, save that:
 - the legend “BUS STAND” may be omitted; and
 - the legend “local” may be omitted; and
 - the references to the time of day may be varied or omitted; and
 - references to the month of the year may be added; and
 - references to the day of the week may be added; and
 - references to bank or public holidays may be included; and
 - the direction of an arrow may be varied with the arrow pointing horizontally to the right; and
 - the arrow may be omitted; and
2. directs that, notwithstanding the provisions of Direction 25(1) of the Traffic Signs General Directions 2002 (Part II of SI 2002/3113, “the 2002 Directions”), any of the road markings shown in diagrams 1025.1, 1025.3 and 1025.4 in Schedule 6 to the Traffic Signs Regulations 2002 (Part I of SI 2002/3113, “the 2002 Regulations”) may be used in conjunction with the Authorised Sign A; and
3. directs that any of the road markings shown in diagrams 1025.1, 1025.3 and diagram 1025.4 shall include the legend “BUS STOP” when the legend “BUS STAND” is omitted from the Authorised Sign A; and

**Bus stop clearway with loading only**

4. authorises the erection at the said sites on the said roads of a traffic sign (hereinafter referred to as "the Authorised Sign B") conforming as to size, colour and character with that referenced "Authorised Sign B" in the said set of drawings, save that:
 - the legend "BUS STAND" may be omitted; and
 - the legend "local" may be omitted; and
 - the references to the time limit, the time of day or to the day of the week may be varied or omitted; and
 - references to the month of the year may be added; and
 - references to bank or public holidays may be included; and
 - the direction of the arrows may be varied with the arrows pointing horizontally to the right; and
 - the arrows may be omitted; and
 - the legend "Goods vehicles" may be omitted, in which case the legend "loading" shall be varied to "Loading"; and
5. directs that, notwithstanding the provisions of Direction 25(1) of the 2002 Directions, any of the road markings shown in diagrams 1025.1, 1025.3 and 1025.4 in Schedule 6 to the 2002 Regulations may be used in conjunction with the Authorised Sign B; and
6. directs that any of the road markings shown in diagrams 1025.1, 1025.3 and 1025.4 shall include the legend "BUS STOP" when the legend "BUS STAND" is omitted from the Authorised Sign B; and

No stopping except taxis and loading only

7. authorises the erection at the said sites on the said roads of a traffic sign (hereinafter referred to as "the Authorised Sign C") conforming as to size, colour and character with that referenced "Authorised Sign C" in the said set of drawings, save that:
 - the legend "Goods vehicles" may be omitted, in which case the legend "loading" shall be varied to "Loading"; and
 - the references to the time limit, the time of day or to the day of the week may be varied or omitted; and
 - references to the month of the year may be added; and
 - references to bank or public holidays may be included; and
 - the direction of the arrows may be varied with the arrows pointing horizontally to the right; and
 - the arrows may be omitted; and



8. authorises the placing within the vicinity of the said sites on the said roads of a traffic sign consisting of a road marking (hereafter referred to as "the Authorised Marking A") conforming as to the size, colour and character with the road marking shown in diagram 1028.3, when no legend appears, in Schedule 6 to the 2002 Regulations, save that a continuous longitudinal yellow line 200 millimetres wide shall be placed along the edge of the carriageway in the manner shown in diagram 1025.1 in Schedule 6 to the 2002 Regulations; and
9. directs that the Authorised Sign C shall be placed only in conjunction with the Authorised Marking A; and
10. directs that the Authorised Marking A shall be placed only in conjunction with the Authorised Sign C; and

No stopping except taxis and limited waiting

11. authorises the erection at the said sites on the said roads of a traffic sign (hereinafter referred to as "the Authorised Sign D") conforming as to size, colour and character with that referenced "Authorised Sign D" in the said set of drawings, save that:
 - the references to the time limit, the time of day or to the day of the week may be varied or omitted; and
 - references to the month of the year may be added; and
 - references to bank or public holidays may be included; and
 - the direction of the arrows may be varied with the arrows pointing horizontally to the right; and
 - the arrows may be omitted; and
12. authorises the placing within the vicinity of the said sites on the said roads of traffic sign consisting of a road marking (hereafter referred to as "the Authorised Marking B") conforming as to the size, colour and character with the road marking shown in diagram 1028.4, when no legend appears, in Schedule 6 to the 2002 Regulations, save that a continuous longitudinal yellow line 200 millimetres wide shall be placed along the edge of the carriageway in the manner shown in diagram 1025.1 in Schedule 6 to the 2002 Regulations; and
13. directs that the Authorised Sign D shall be placed only in conjunction with the Authorised Marking B; and
14. directs that the Authorised Marking B shall be placed only in conjunction with the Authorised Sign D; and



Loading only and limited waiting

15. authorises the erection at the said sites on the said roads of a traffic sign (hereinafter referred to as "the Authorised Sign E") conforming as to size, colour and character with that referenced "Authorised Sign E" in the said set of drawings, save that:
- the legend "Goods vehicles" may be omitted, in which case the legend "loading" shall be varied to "Loading"; and
 - the references to the time limit, the time of day or to the day of the week may be varied or omitted; and
 - references to the month of the year may be added; and
 - references to bank or public holidays may be included; and
 - the direction of the arrows may be varied with the arrows pointing horizontally to the right; and
 - the arrows may be omitted; and
16. directs that, notwithstanding the provisions of Direction 25(1) of the 2002 Directions, any of the road markings shown in diagrams 1028.3, 1028.4, 1032 and 1033, in each case when no legend appears, in Schedule 6 to the 2002 Regulations, may be used in conjunction with the Authorised Sign E; and

Loading only and disabled badge parking

17. authorises the erection at appropriate sites on the said roads of a traffic sign (hereinafter referred to as "the Authorised Sign F") conforming as to size, colour and character with that referenced "Authorised Sign F" in the said set of drawings, save that:
- the legend "Goods vehicles" may be omitted, in which case the legend "loading" shall be varied to "Loading"; and
 - the references to the time limit, the time of day or to the day of the week may be varied or omitted; and
 - references to the month of the year may be added; and
 - references to bank or public holidays may be included; and
 - the direction of the arrows may be varied with the arrows pointing horizontally to the right; and
 - the arrows may be omitted; and
18. directs that, notwithstanding the provisions of Direction 25(1) of the 2002 Directions, any of the road markings shown in diagrams 1028.3, 1032 and 1033, in each case when no legend appears, in Schedule 6 to the 2002 Regulations, may be used in conjunction with the Authorised Sign F; and



Pay by phone parking

19. authorises the erection, at appropriate sites on the said roads, of a traffic sign (hereinafter referred to as "the Authorised Sign G") conforming as to size, colour and character with that referenced "Authorised Sign G" in the said set of drawings, save that:
- the references to the time limit, the time of day or the day of the week may be varied or omitted; and
 - references to the month of the year may be added; and
 - references to bank or public holidays may be included; and
 - the legend "Resident" may be omitted, in which case the legend "permit holders" shall be varied to "Permit holders"; and
 - the legend "Resident permit holders" may be omitted, in which case the permit parking identification patch shall also be omitted; and
 - the permit parking identification patch may be varied; and
 - the telephone number, the text number and the location code may be varied; and
 - the legend "or text" may be omitted, in which case the text number shall be omitted; and
 - the legend "Pay at machine" may be replaced by the legend "Pay at machine opposite" (on two lines), in which case the arrow shall be omitted; and
 - the legend "Pay at machine" may be replaced by the legend "Pay here at machine" (on two lines), in which case the arrow shall be omitted; and
 - an arrow may be added below the reference to the time of day; and
 - the direction of an arrow may be varied with the arrow pointing horizontally to the left or to the right; and
20. directs that, notwithstanding the provisions of Direction 25(1) of the 2002 Directions, any of the road markings shown in diagrams 1028.4, 1032 and 1033, in each case when no legend appears, in Schedule 6 to the 2002 Regulations, may be used in conjunction with the Authorised Sign G; and

Chevron signs to denote a sharp change in the direction of the road

21. authorises the erection at the said sites on the said roads, of a traffic sign (hereinafter referred to as "the Authorised Sign H") conforming as to size, colour and character with that referenced "Authorised Sign H" in the said set of drawings; and
22. authorises the erection at appropriate roundabout sites on the said roads of a traffic sign (hereinafter referred to as "the Authorised Sign I") conforming as to size, colour and character with that referenced "Authorised Sign I" in the said set of drawings; and

**School children warning and advisory 20 mph limit**

23. authorises the erection at the said sites on the said roads of a traffic sign consisting of a plate (hereinafter referred to as "the Authorised Plate A") conforming as to size, colour and character with that referenced "Authorised Plate A" in the said set of drawings; and
24. directs that, notwithstanding the provisions of Direction 55(1) of the 2002 Directions, the Authorised Plate A shall be placed between the sign shown in diagram 545 in Schedule 1 to the 2002 Regulations (placed uppermost) and the light signals shown in diagram 4004 in Schedule 9 to the 2002 Regulations; and

Private Hire Vehicles and solo motorcycles in near-side with-flow bus lanes

25. authorises the erection at the said sites on the said roads of a traffic sign (hereinafter referred to as "the Authorised Sign J") conforming as to size, colour and character with that referenced "NP 958.12" in the said set of drawings; and
26. authorises the erection at the said sites on the said roads of a traffic sign (hereinafter referred to as "the Authorised Sign K") conforming as to size, colour and character with that referenced "NP 959.10" in the said set of drawings; and
27. directs that, notwithstanding the provisions of Direction 21 of the 2002 Directions, the plate shown in diagrams 961 in Schedule 5 to the 2002 Regulations may be used in conjunction with the Authorised Signs J and K; and
28. directs that the Authorised Sign J may be used in the vicinity of the road marking to diagram 1010 (when laid diagonally) in Schedule 6 to the 2002 Regulations; and
29. directs that, notwithstanding the provisions of Direction 18(3) of the 2002 Directions, the road markings shown in diagrams 1048 and 1049 in Schedule 6 to the 2002 Regulations shall be used in conjunction with the Authorised Sign K; and

Private Hire Vehicles in near-side with-flow bus lanes

30. authorises the erection at the said sites on the said roads of a traffic sign (hereinafter referred to as "the Authorised Sign L") conforming as to size, colour and character with that referenced "NP 958.13" in the said set of drawings; and
31. authorises the erection at the said sites on the said roads of a traffic sign (hereinafter referred to as "the Authorised Sign M") conforming as to size, colour and character with that referenced "NP 959.11" in the said set of drawings; and
32. directs that, notwithstanding the provisions of Direction 21 of the 2002 Directions, the plate shown in diagram 961 in Schedule 5 to the 2002 Regulations may be used in conjunction with the Authorised Signs L and M; and
33. directs that the Authorised Sign L may be used in the vicinity of the road marking to diagram 1010 (when laid diagonally) in Schedule 6 to the 2002 Regulations; and



34. directs that, notwithstanding the provisions of Direction 18(3) of the 2002 Directions, the road markings shown in diagrams 1048 and 1049 in Schedule 6 to the 2002 Regulations shall be used in conjunction with the Authorised Sign M; and

Rising bollards

35. authorises the erection at the said sites on the said roads of a traffic sign (hereinafter referred to as "the Authorised Sign N") conforming as to size, colour and character with that referenced "Authorised Sign N" in the said set of drawings; and

36. authorises the erection at the said sites on the said roads of a traffic sign consisting of a plate (hereinafter referred to as "the Authorised Plate B") conforming as to size, colour and character with that referenced "the Authorised Plate B" in the said set of drawings; and

37. authorises the erection at the said sites on the said roads of a traffic sign consisting of a light signal (hereinafter referred to as "the Authorised Indicator") conforming as to the light signal shown in diagram 3000 in Schedule 8 to the 2002 Regulations, save that:

- the amber aspect shall be omitted; and
- the red aspect and the green aspect shall have a minimum diameter of 100 millimetres; and
- the minimum mounting height of the centre of the green aspect shall be 1000 millimetres; and

38. directs that the Authorised Sign N shall be placed to face waiting drivers; and

39. directs that, notwithstanding the provisions of Direction 20(1) of the 2002 Directions, the sign shown in diagram 562 in Schedule 1 to the 2002 Regulations may be used in combination with the Authorised Plate B; and

40. directs that the green indicator contained in the Authorised Indicator shall be illuminated only while the bollards referred to on the Authorised Sign N are fully retracted, and that the red indicator shall be illuminated at all other times; and

41. directs that the Authorised Indicator may be erected at the said sites only if the apparatus used in connection with it (including the content of all instructions stored in or executable by it) has been approved in writing by the Secretary of State; and

Countdown

42. authorises the erection at the said sites on the said roads of a traffic sign consisting of a light signal (hereinafter referred to as "the Authorised Light Signal") conforming as to size, colour and character with either of the designs referenced "Authorised Light Signal" in the said set of drawings; and



43. directs that, notwithstanding the provision of Direction 55(4) of the 2002 Directions, the Authorised Light Signal shall be used in conjunction with the light signal shown in diagram 4003 in Schedule 9 to the 2002 Regulations; and
44. directs that the Authorised Light Signal may only be placed at the said sites if the apparatus (including the content of all instructions stored in it) used in connection with it is of a type which has been agreed by the Secretary of State as appropriate to the site and application; and
45. directs that the Authorised Light Signal shall be used in conjunction with the light signal shown in diagram 3000 in Schedule 8 to the 2002 Regulations; and
46. directs that the countdown unit in the Authorised Light Signal shall only be illuminated when the red and green pedestrian aspects of the said signal are not illuminated, and shall not be illuminated at any other time; and

In the Authorised Light Signal:

- the red pedestrian aspect, while it is illuminated, shall convey to pedestrians the warning that, in the interests of safety, they should not cross the carriageway; and
- the green pedestrian aspect, while it is illuminated, shall convey to pedestrians the indication that they may cross the carriageway; and
- the countdown unit, while it is illuminated, shall convey to pedestrians the remaining time in which they may cross the carriageway; and

Contrasting bays

47. authorises the placing at the said sites on the said roads of a traffic sign consisting of a road marking (hereinafter referred to as "the Authorised Marking C") conforming as to size with the road marking shown in diagram 1028.3, when no legend appears, in Schedule 6 to the 2002 Regulations, save that the Authorised Marking C shall be delineated with surfacing or paving contrasting in colour or appearance with the surrounding carriageway; and
48. authorises the placing at the said sites on the said roads of a traffic sign consisting of a road marking (hereinafter referred to as "the Authorised Marking D") conforming as to size with the road marking shown in diagram 1028.4, when no legend appears, in Schedule 6 to the 2002 Regulations, save that the Authorised Marking D shall be delineated with surfacing or paving contrasting in colour or appearance with the surrounding carriageway; and
49. authorises the placing at the said sites on the said roads of a traffic sign consisting of a road marking (hereinafter referred to as "the Authorised Marking E") conforming as to size with the road marking shown in diagram 1033, when no legend appears, in Schedule 6 to the 2002 Regulations, save that the Authorised Marking E shall be delineated with surfacing or paving contrasting in colour or appearance with the surrounding carriageway; and



50. directs that, notwithstanding the provisions of Direction 24(1) of the 2002 Directions, any of the signs shown in diagrams 639.1B, 660, 660.4 and 661.1, in Schedule 2 to the 2002 Regulations may be used in conjunction with the Authorised Marking C; and
51. directs that, notwithstanding the provisions of Direction 24(1) of the 2002 Directions, any of the signs shown in diagrams 660, 660.3, 660.5, 660.6, 660.7, 661.2A, 661.3A and 662 in Schedule 2 to the 2002 Regulations may be used in conjunction with the Authorised Marking D; and
52. directs that, notwithstanding the provisions of Direction 24(1) of the 2002 Directions, any of the signs shown in diagrams 660, 660.3, 660.4, 660.5, 660.6, 660.7, 661.1, 661.2A, 661.3A and 662 in Schedule 2 to the 2002 Regulations may be used in conjunction with the Authorised Marking E; and
53. directs that it is a condition of this authorisation that the Authorised Signs A, B, C, D, E, F, G, I, K, M and N, the Authorised Plate B, the Authorised Indicator, and the Authorised Markings A, B, C, D and E may be placed only to indicate the effect of a corresponding Traffic Regulation Order; and
54. directs, without prejudice to any statutory provision to the like effect, that it is a condition of this authorisation that the erection of the Authorised Signs A, B, C, D, E, F, G, H, I, J, K, L, M and N, the Authorised Plates A and B, the Authorised Indicator, the Authorised Light Signal, and the Authorised Markings A, B, C, D and E, at or near the said sites shall continue to have effect only until such day as may be appointed by one month's notice given by the Secretary of State in writing to the traffic authority for the removal or alteration of the Authorised Signs A, B, C, D, E, F, G, H, I, J, K, L, M and N, the Authorised Plates A and B, the Authorised Indicator, the Authorised Light Signal, and the Authorised Markings A, B, C, D and E, and on that day the said authorisation shall, without prejudice to the giving of any further authorisation or direction, cease to have effect.

The provisions of Regulations 12, 17, 18 and 19 of the 2002 Regulations shall apply to the Authorised Sign A in the same manner as they apply to the sign shown in diagram 975 in Schedule 5 to those Regulations.

The provisions of Regulations 12, 17, 18 and 19 of the 2002 Regulations shall apply to the Authorised Signs B, C, and D in the same manner as they apply to the sign shown in diagram 639.1B in Schedule 2 to those Regulations.

The provisions of Regulations 12, 17, 18 and 19 of the 2002 Regulations shall apply to any of the Authorised Signs E, F and G in the same manner as they apply to the sign shown in diagram 660.4 in Schedule 2 to those Regulations.

The provisions of Regulations 12, 17, 18 and 19 of the 2002 Regulations shall apply to the Authorised Sign H in the same manner as they apply to the sign shown in diagram 515.1 in Schedule 1 to those Regulations.



The provisions of Regulations 12, 17, 18 and 19 of the 2002 Regulations shall apply to the Authorised Sign I in the same manner as they apply to both the sign shown in diagram 515.1A in Schedule 1 to those Regulations and to the sign shown in diagram 606 in Schedule 2 to those Regulations.

The provisions of Regulations 12, 17, 18 and 19 of the 2002 Regulations shall apply to the Authorised Signs J and L in the same manner as they apply to the sign shown in diagram 958 in Schedule 5 to those Regulations.

The provisions of Regulations 12, 17, 18 and 19 of the 2002 Regulations shall apply to the Authorised Signs K and M in the same manner as they apply to the sign shown in diagram 959 in Schedule 5 to those Regulations.

The provisions of Regulations 12, 17, 18 and 19 of the 2002 Regulations shall apply to the Authorised Sign N in the same manner as they apply to the sign shown in diagram 637.2 in Schedule 2 to those Regulations.

The provisions of Regulations 12 and 20 of the 2002 Regulations shall apply to the Authorised Plates A and B in the same manner as they apply to the plate shown in diagram 563 when used in combination with the sign shown in diagram 562 in Schedule 1 to those Regulations.

The provisions of Regulations 12 of the 2002 Regulations shall apply to the Authorised Indicator in the same manner as they apply to the sign shown in diagram 4002.1 in Schedule 9 to those Regulations.

The provisions of Regulations 12 and 47 of the 2002 Regulations shall apply to the Authorised Light Signal in the same manner as they apply to the light signal shown in diagram 4002.1 in Schedule 9 to those Regulations.

The provisions of Regulations 12, 31 and 43 of the 2002 Regulations shall apply to the Authorised Markings A and B in the same manner as they apply to the road marking shown in diagram 1028.3 in Schedule 6 to those Regulations.

The provisions of Regulation 12 of the 2002 Regulations shall apply to the Authorised Markings C, D and E in the same manner as they apply to the road marking shown in diagram 1028.3 in Schedule 6 to those Regulations.

Dated 17 October 2011

Signed by authority of the Secretary of State



A Delegated Official in the Department for Transport





Authorised Sign A	Tile edges do not form part of the sign
x-height (mm)	20 min - 40 max
Illumination requirements	Traffic Signs Regulations and General Directions 2002, Schedule 17 item 4
Colours	See Appendix
Department for Transport	GT50/100/0007-1
Date	17 October 2011



Authorised Sign B	Tile edges do not form part of the sign
x-height (mm)	20 min - 40 max
Illumination requirements	Traffic Signs Regulations and General Directions 2002, Schedule 17 item 4
Colours:	See Appendix



Authorised Sign C	Tile edges do not form part of the sign
x-height (mm)	20 min - 40 max
Illumination requirements	Traffic Signs Regulations and General Directions 2002, Schedule 17 item 4
Colours:	See Appendix



Authorised Sign D	Tile edges do not form part of the sign
x-height (mm)	20 min - 40 max
Illumination requirements	Traffic Signs Regulations and General Directions 2002, Schedule 17 item 4
Colours:	See Appendix



Authorised Sign E	Tile edges do not form part of the sign
x-height (mm)	15 min - 40 max
Illumination requirements	Traffic Signs Regulations and General Directions 2002, Schedule 17 item 9
Colours:	See Appendix



Authorised Sign F	Tile edges do not form part of the sign
x-height (mm)	15 min - 40 max
Illumination requirements	Traffic Signs Regulations and General Directions 2002, Schedule 17 item 9
Colours:	See Appendix

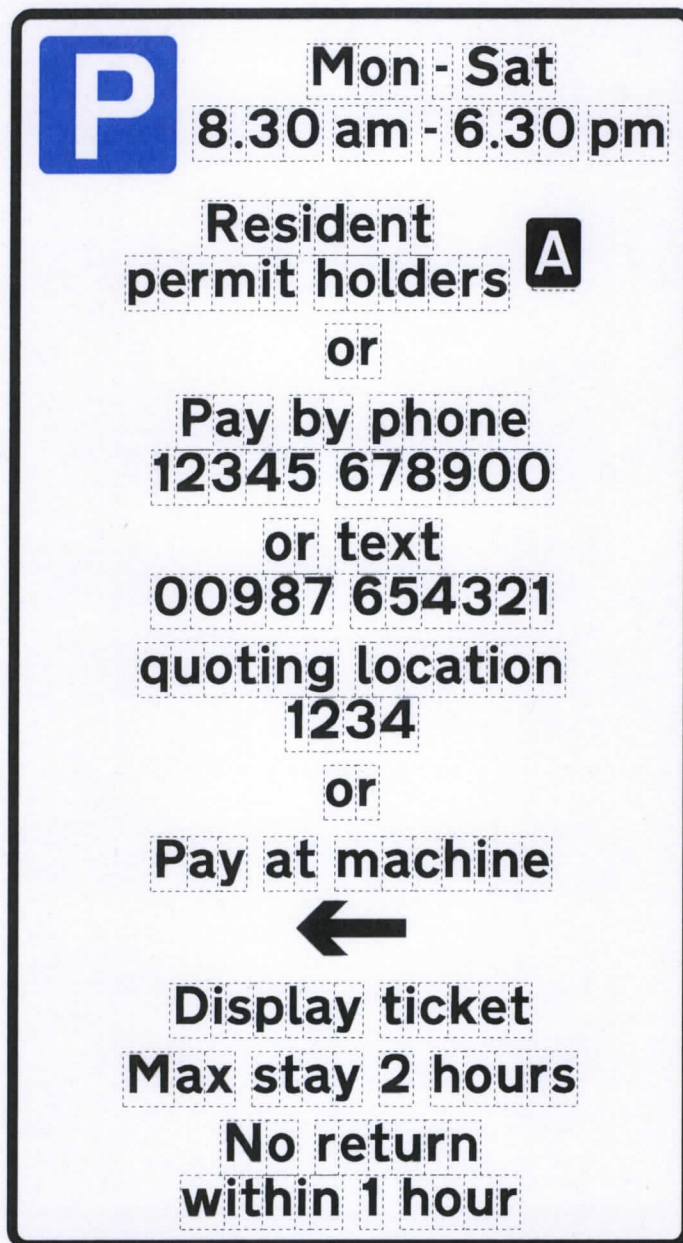

Authorised Sign G	Tile edges do not form part of the sign
x-height (mm)	15 min - 40 max
Illumination requirements	Traffic Signs Regulations and General Directions 2002, Schedule 17 item 9
Colours:	See Appendix

MODEL SPECIFICATION - ADVANCED CHEVROFLEX™ - HIGH VISIBILITY BACKING
BENDS

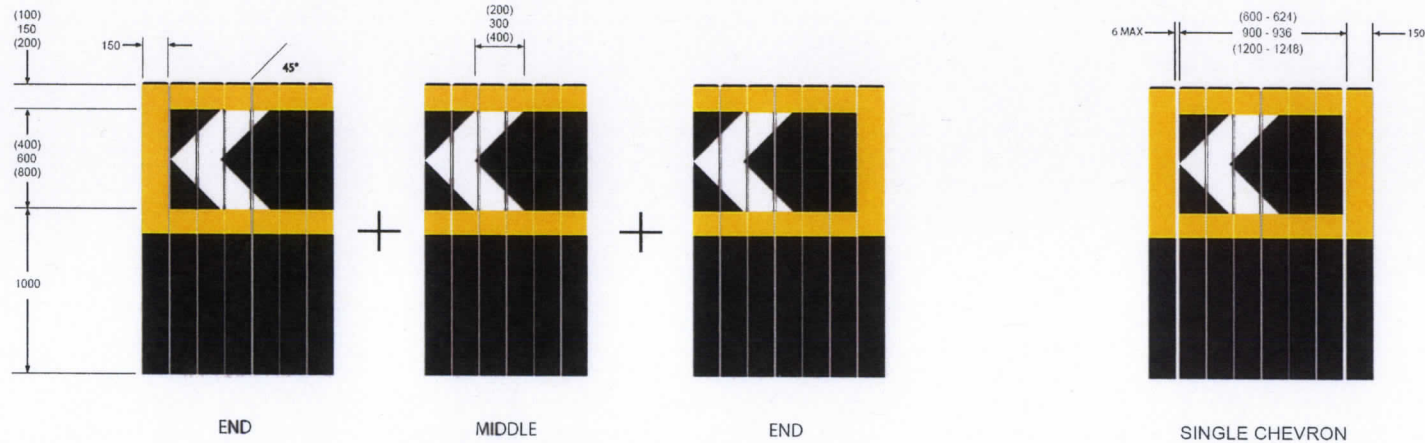

Number of Uprights
will vary as shown.
400 Chevron = 4
600 Chevron = 6
800 Chevron = 8

Notes:

1. Authorisation is required from the Department for Transport in order for this product to be used. This will be granted on an authority wide basis.
2. Fluorescent yellow and white retroreflective material shown from 02S061-S17 are as recommended in table NA1 of the National Annex of BS EN 12899-1 2007 Fixed Vertical Road Signs.

Microprismatic retroreflective materials used on our products meet the requirements of BS 8408 2005 Road Traffic Signs. Testing and Performance of Microprismatic Retroreflective Sheeting Materials when sited normally and used for their normal application.
3. Left Hand Bend shown. The direction of the chevron may be varied with the chevron pointing horizontally to the left or to the right.

DRG. TITLE				 Glasdon [®] Glasdon Group Limited IEC, Preston New Road, Blackpool, Lancashire, FY4 4UY Telephone: 01253 600400 Fax: 01253 792558 e-mail: design@glasdon.com website: www.glasdon.com
PROJECT				
DRG. No.		PROJECT No.		
SCALE		DATE	09/06/10	
DRAWN BY	B Diep	CHECKED		SPECIFICATION No 02S061-317 ISSUE 2
© GLASDON GROUP Ltd. 09.06.10				SHEET SIZE: A2

MODEL SPECIFICATION - ADVANCED CHEVROFLEX™ - HIGH VISIBILITY BACKING
 ROUNDABOUT C/W 606 SIGN

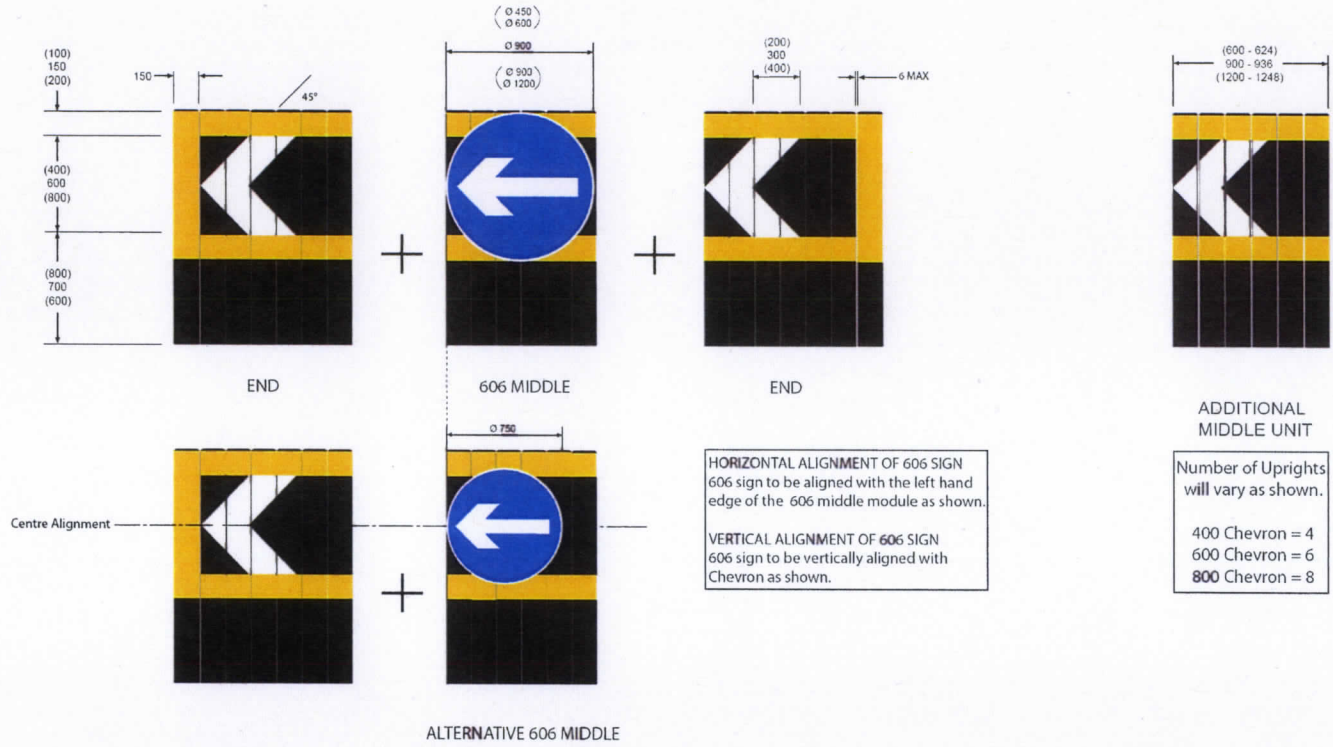

HORIZONTAL ALIGNMENT OF 606 SIGN
 606 sign to be aligned with the left hand edge of the 606 middle module as shown.

VERTICAL ALIGNMENT OF 606 SIGN
 606 sign to be vertically aligned with Chevron as shown.

Number of Uprights will vary as shown.

400 Chevron = 4
 600 Chevron = 6
 800 Chevron = 8

Notes:

1. Authorisation is required from the Department for Transport in order for this product to be used. This will be granted on an authority wide basis.
 2. Fluorescent yellow and white retroreflective material shown from 02S061-S18 are as recommended in table NA1 of the National Annex of BS EN 12899-1 2007 Fixed Vertical Road Signs.
- Microprismatic retroreflective materials used on our products meet the requirements of BS 5408 2005 Road Traffic Signs. Testing and Performance of Microprismatic Retroreflective Sheeting Materials when sited normally and used for their normal application.

DRG TITLE				 <p>Glasdon Group Limited IEC, Preston New Road, Blackpool, Lancashire, FY4 4UY Telephone: 01253 600400 Fax: 01253 792558 e-mail: design@glasdon.com website: www.glasdon.com</p>
PROJECT				
DRG No		PROJECT No		
SCALE		DATE	09/06/10	
DRAWN BY	B Diep	CHECKED		SPECIFICATION No. 02S061 - S18 ISSUE 2 © GLASDON GROUP Ltd 09.05.10 SHEET SIZE: A2

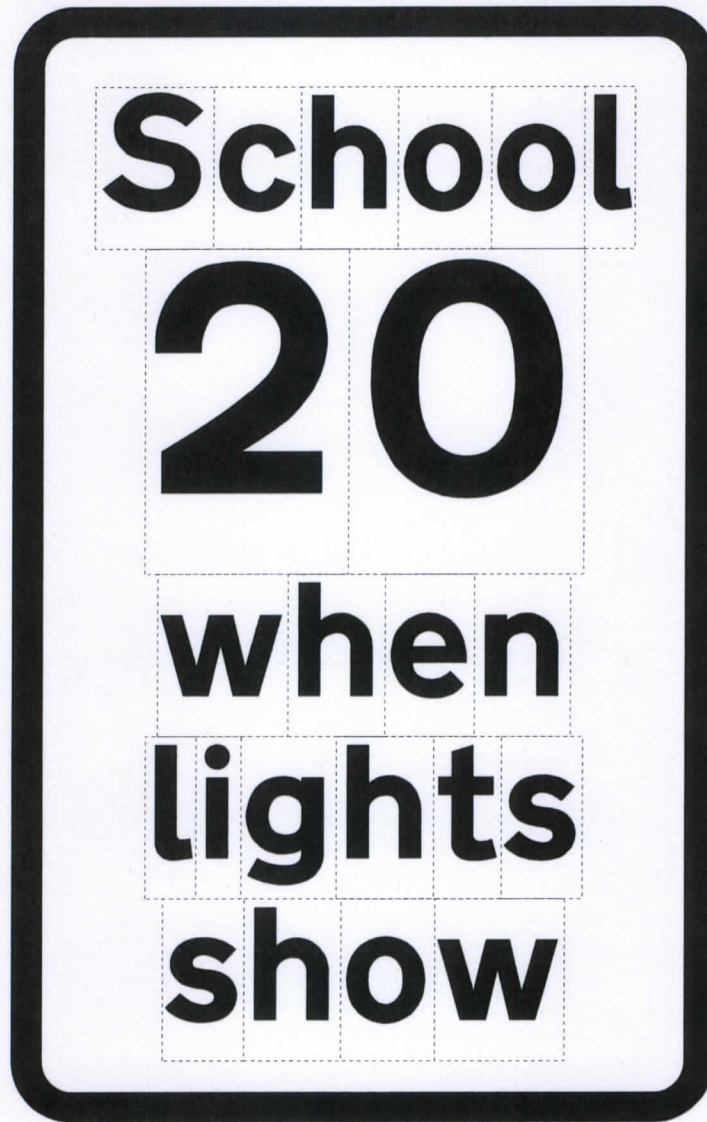

Authorised Plate A	Tile edges do not form part of the sign
x-height (mm)	50 and 100
Illumination requirements	Traffic Signs Regulations and General Directions 2002, Schedule 17 item 8
Colours:	See Appendix

Drawing No.
NP 958.12

Related Drawings
S 23, S 24,
& S 25

© CROWN COPYRIGHT

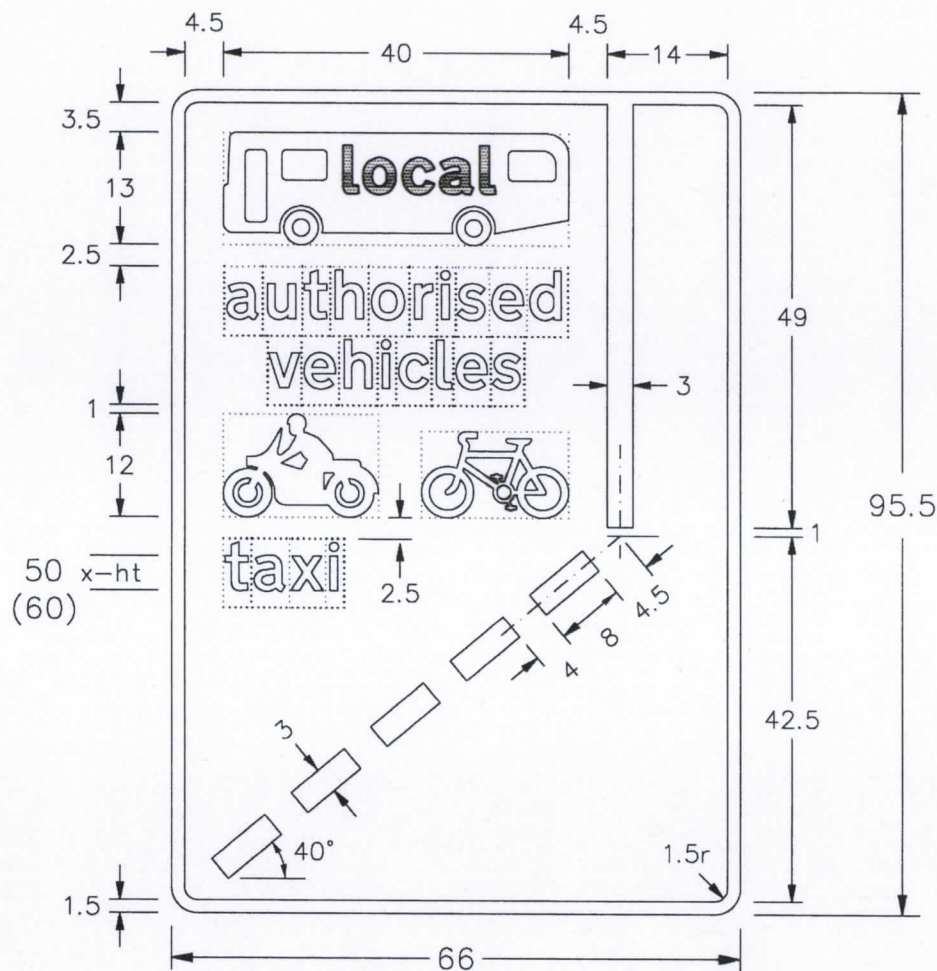

- NOTES:
1. The legend is from the Transport Medium alphabet at the x-heights shown. The word 'local' on the bus is from the Transport Heavy alphabet.
 2. Symbol details are given on drawings S 23, S 24 and S 25 sheets 1 & 2. The symbols must always face left.
 3. The tile outlines do not form part of the sign.
 4. COLOURS: -
Background ----- BLUE
Legend, Symbols & Border ---- WHITE
Legend on bus symbol ----- BLACK
 5. DIMENSIONS : x-heights are in millimetres, other dimensions are in stroke widths. (4sw = x-height)
 6. The legend 'local' may be omitted and the bus symbol varied to the one shown on drawing S 25 sheet 1. A time plate may be added in the same colours (see drawing P 961).

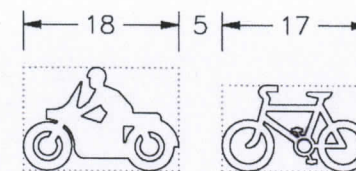

NP958x12

Before using this drawing, confirm that it has not been superseded.

**Department for
Transport**

Title: Informatory Sign
BUS, AUTHORISED VEHICLES
AND MOTOR CYCLE LANE AHEAD

Issue: Date:
A: 12.8.05
B:
C:

Drawn by:
L.W./R.M.
Approved by:
R.M.

Dimensions:
SEE
NOTE 5

Drawing No.
NP 958.12

Drawing No.
NP 959.10

Related Drawings
S 23, S 24,
& S 25

© CROWN COPYRIGHT

NOTES: 1. The legend is from the Transport Medium alphabet at the x-heights shown. The word 'local' on the bus is from the Transport Heavy alphabet.

2. Symbol details are given on drawings S 23, S 24 and S 25 sheets 1 & 2. The symbols must always face left.

3. The tile outlines do not form part of the sign.

4. COLOURS: -
Background ----- BLUE
Legend, Symbols & Border ---- WHITE
Legend on bus symbol ----- BLACK

5. DIMENSIONS : x-heights are in millimetres, other dimensions are in stroke widths. (4sw = x-height)

6. The legend 'local' may be omitted and the bus symbol varied to the one shown on drawing S 25 sheet 1. A time plate may be added in the same colours (see drawing P 961).

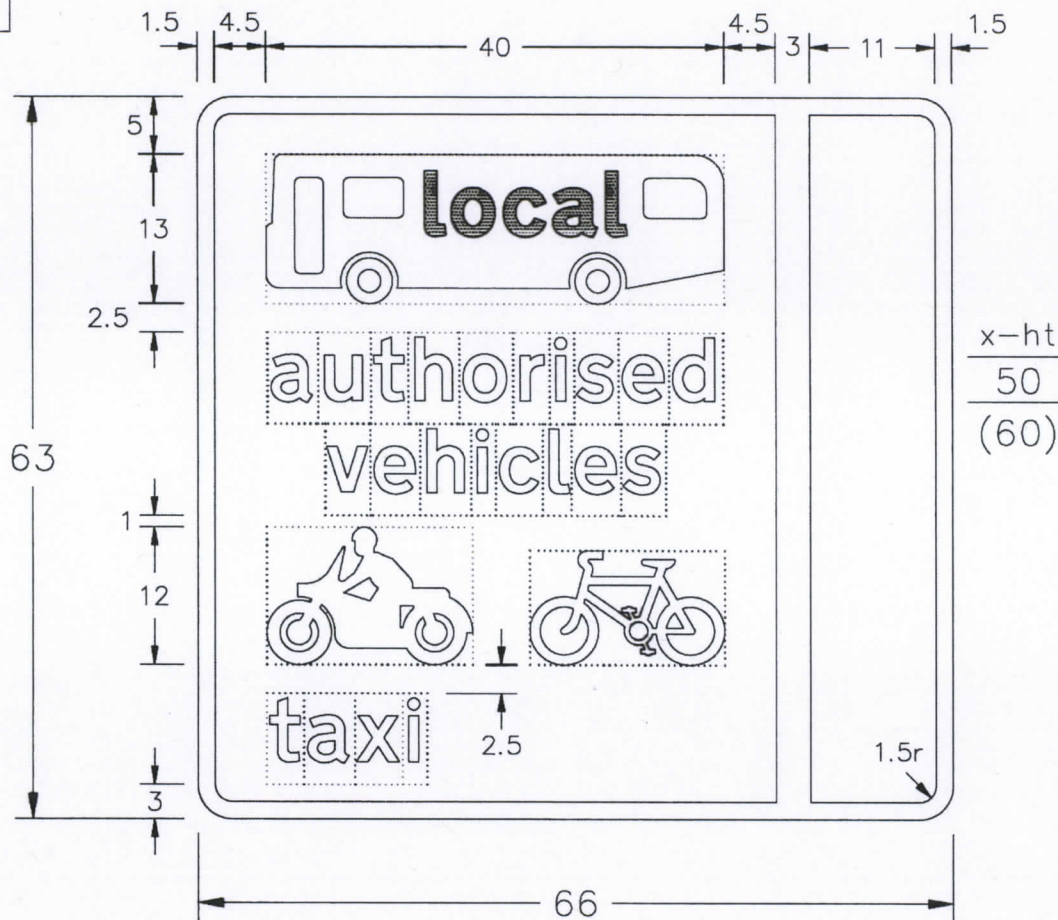

$$\frac{x-ht}{50} (60)$$

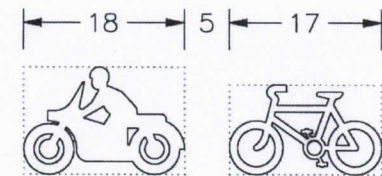

NP959x10

Before using this drawing, confirm that it has not been superseded.

<p>Department for Transport</p>	<p>Title: Regulatory Sign</p>	<p>Issue: Date:</p>	<p>Drawn by:</p>	<p>Dimensions:</p>	<p>Drawing No.</p>
	<p>BUS, AUTHORISED VEHICLES AND MOTOR CYCLE LANE</p>	<p>A: 12.8.05</p> <p>B:</p> <p>C:</p>	<p>L.W./R.M.</p> <p>Approved by:</p> <p>R.M.</p>	<p>SEE NOTE 5</p>	<p>NP 959.10</p>

Drawing No.
NP 958.13

Related Drawings
S 24, S 25

© CROWN COPYRIGHT

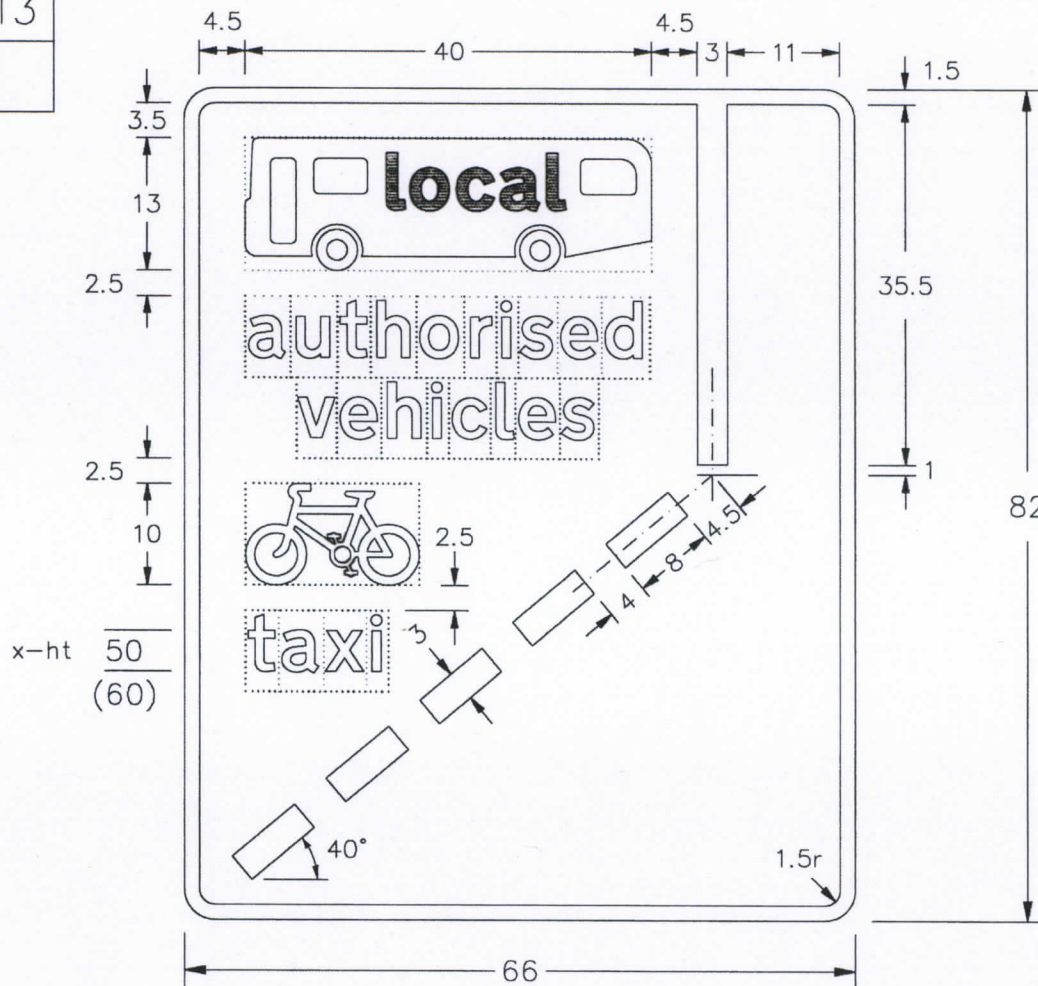

- NOTES:
1. The legend is from the Transport Medium alphabet at the x-heights shown. The word 'local' on the bus is from the Transport Heavy alphabet.
 2. Symbol details are given on drawings S 24 and S 25. The symbols must always face left.
 3. The tile outlines do not form part of the sign.
 4. COLOURS:—
Background ----- BLUE
Legend, Symbols & Border ---- WHITE
Legend on bus symbol ----- BLACK
 5. DIMENSIONS : x-heights are in millimetres, other dimensions are in stroke widths. (4sw = x-height)
 6. The legend 'taxi' may be omitted. The legend 'local' may be omitted and the bus symbol varied to the one shown on drawing S 25 sheet 1.
 7. A time plate may be added in the same colours (see drawing P 961).

P958x13

Before using this drawing, confirm that it has not been superseded.

**Department for
Transport**

Title: Informatory Sign
BUS and AUTHORISED VEHICLES
LANE AHEAD

Issue: Date:
A: 16.2.06
B:
C:

Drawn by:
L.W.
Approved by:
R.M.

Dimensions:
SEE
NOTE 5

Drawing No.
NP 958.13

Drawing No.
NP 959.11

Related Drawings
S 24 & S 25

© CROWN COPYRIGHT

- NOTES: 1. The legend is from the Transport Medium alphabet at the x-heights shown. The word 'local' on the bus is from the Transport Heavy alphabet.
2. Symbol details are given on drawings S 24 and S 25. The symbols must always face left.
3. The tile outlines do not form part of the sign.
4. COLOURS : Background ----- BLUE
Legend, Symbols & Border ---- WHITE
Legend on bus symbol ----- BLACK
5. DIMENSIONS : x-heights are in millimetres, other dimensions are in stroke widths. (4sw = x-height)
6. VARIANTS : The legend 'taxi' may be omitted. The legend 'local' may be omitted and the bus symbol replaced with the one shown on drawing S 25 sheet 1.
7. A time plate may be added in the same colours (see drawing P 961).

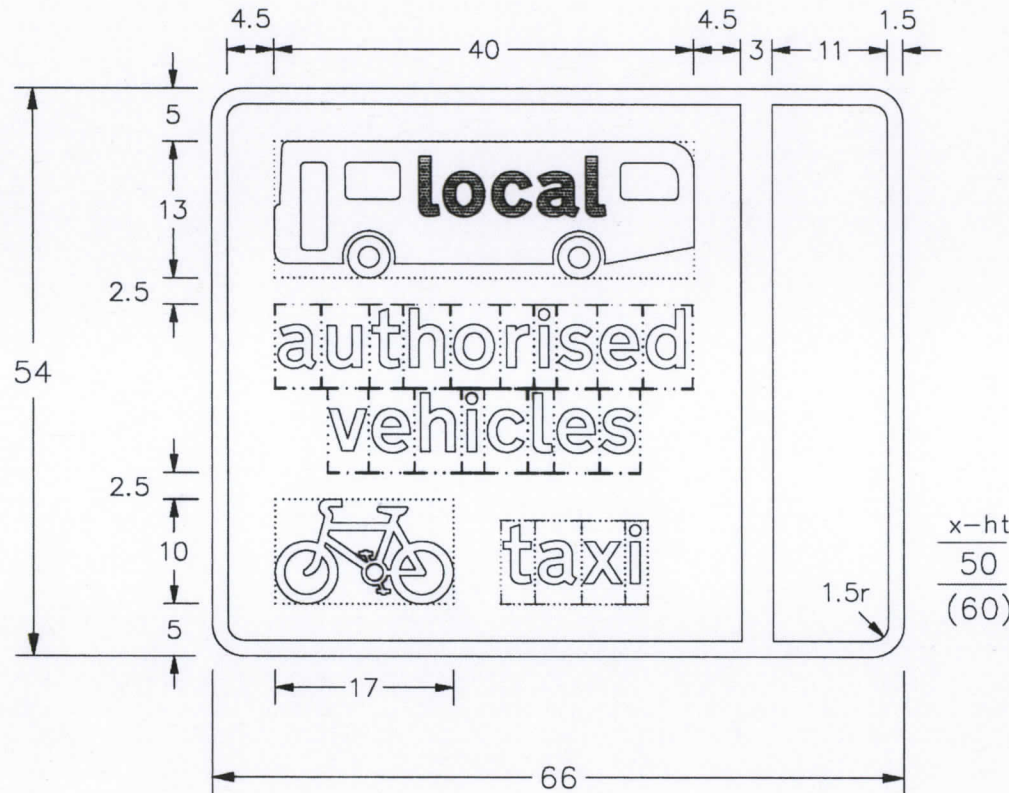

P959x11

Before using this drawing, confirm that it has not been superseded.

Department for Transport	Title: Regulatory Sign	Issue: Date:	Drawn by:	Dimensions:	Drawing No.
	BUS and AUTHORISED VEHICLES LANE	A: 16.2.06	L.W.	SEE NOTE 5	NP 959.11
		B:	Approved by:	R.M.	

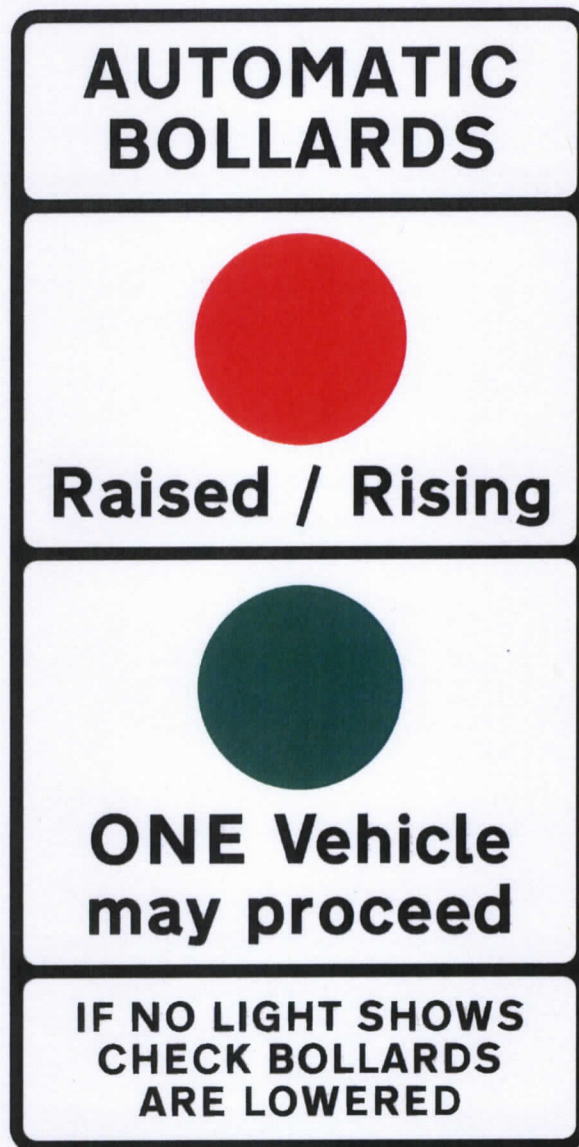

Authorised Sign N	Tile edges do not form part of the sign
x-height (mm)	37.5
Red / Green Aspect (mm)	100
Illumination requirements	Traffic Signs Regulations and General Directions 2002, Schedule 17 item 9
Colours:	See Appendix

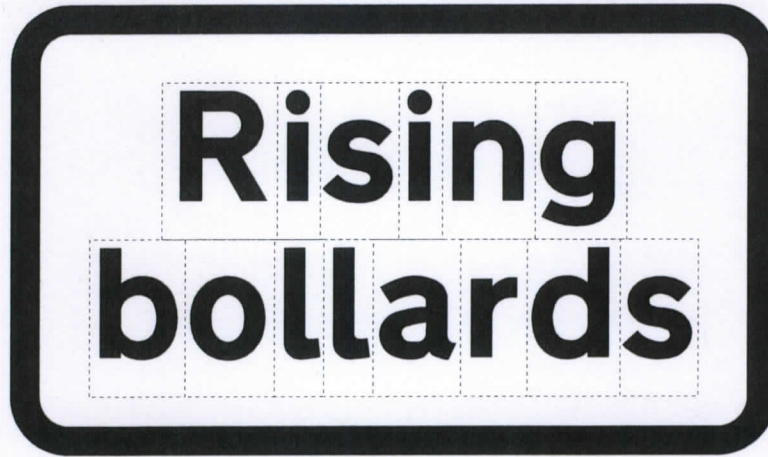

Authorised Plate B	Tile edges do not form part of the sign
x-height (mm)	62.5 min - 75 max
Illumination requirements	Traffic Signs Regulations and General Directions 2002, Schedule 17 item 8
Colours:	See Appendix

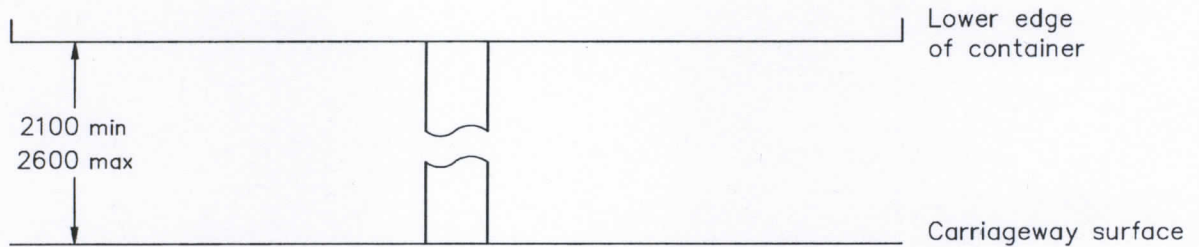
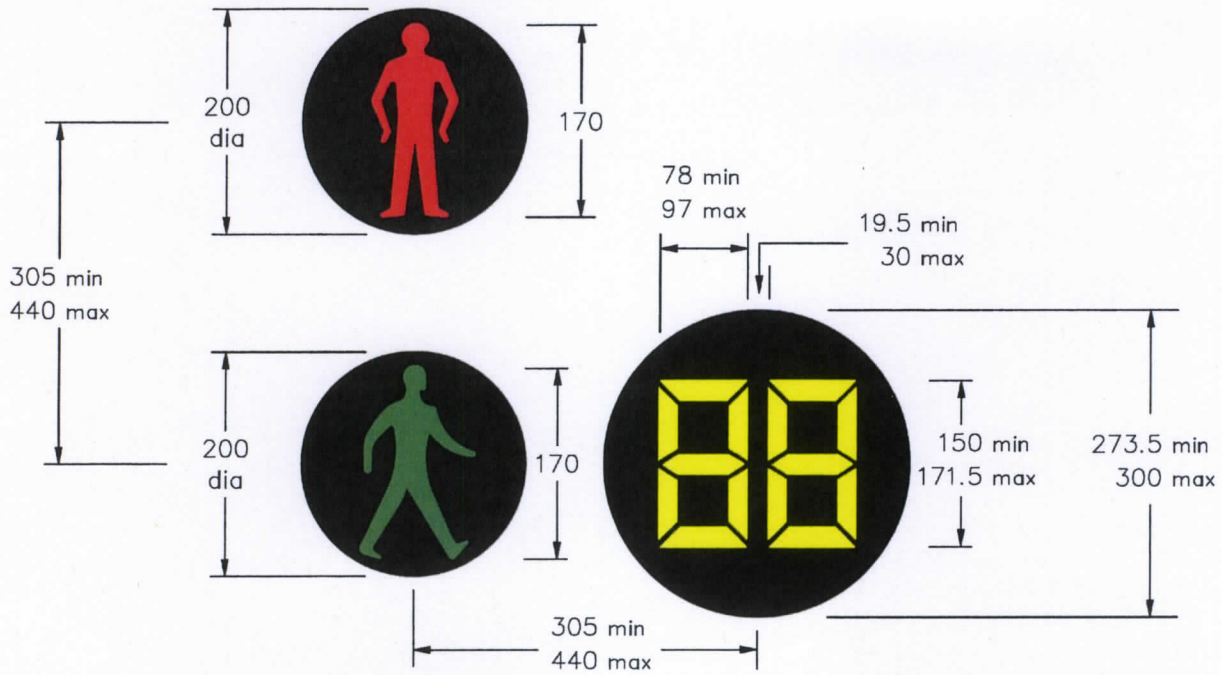

Authorised Light Signal	Dimensions do not form part of the sign
Performance requirements:	
Red/green figures	BS EN 12368: 2006
Countdown unit numerical display	BS EN 12966-1: 2005+A1: 2009

Standard Colours for Traffic Signs

The colours used for sign faces must conform to the chromaticity requirements specified in BS EN 12899-1. The National Annex recommends appropriate classes for UK use. As an aid to comparison, however, the table below lists the equivalent colours from BS 381C.

Colour (from BS EN 12899-1)	Equivalent colour (from BS 381C)
White	N/A
Yellow	No 355 (Lemon)
Red	No 537 (Signal Red)
Blue	No 109 (Middle Blue)
Green	No 225 (Light Brunswick Green)
Black	N/A

Standard Colours for Road Markings

The colours white and yellow are prescribed for road markings. Those markings associated with red routes require special authorisation and there are currently no plans to prescribe them.

The colours used for road markings must conform to the chromaticity requirements in BS EN 1436. For comparison, however, the equivalent colours from BS 381C are described below.

The standard colour for waiting and loading restriction road markings is No 355 (Lemon). No 309 (Canary) is also acceptable. However, in environmentally sensitive areas No 310 (Primrose) or No 353 (Deep Cream) may be used.