



**ROAD TRAFFIC REGULATION ACT 1984 – SECTIONS 64 AND 65
AUTHORISATION OF TRAFFIC SIGNS AND SPECIAL DIRECTIONS**

The Secretary of State for Transport, in exercise of his powers under Sections 64 and 65 of the Road Traffic Regulation Act 1984, and of all other powers enabling him in that behalf, for the purpose of informing road users of the conditions of use of roads in the vicinity of the Midland Metro tram system in Sandwell; hereby:-

1. authorises the erection at appropriate sites on roads for which Sandwell Metropolitan Borough Council is the traffic authority of a traffic sign (hereinafter referred to as “the authorised sign A”) conforming as to size, colour and character with that referenced “MMA NPA-001” in the attached set of drawings numbered GT50/152/0016-1; and
2. authorises the erection at the said sites of a traffic sign (hereinafter referred to as “the authorised sign B”) conforming as to size, colour and character with that referenced “MMA NPA-002” in the said set of drawings; and
3. authorises the erection at the said sites of a traffic sign (hereinafter referred to as “the authorised sign C”) conforming as to size, colour and character with that referenced “MMA NPA-003” in the said set of drawings; and
4. authorises the erection at the said sites of a traffic sign (hereinafter referred to as “the authorised sign D”) conforming as to size, colour and character with that referenced “MMA NPA-004” in the said set of drawings; and
5. authorises the erection at the said sites of a traffic sign (hereinafter referred to as “the authorised sign E”) conforming as to size, colour and character with that referenced “MMA NPA-005” in the said set of drawings; and
6. authorises the erection at the said sites of a traffic sign (hereinafter referred to as “the authorised sign F”) conforming as to size, colour and character with that referenced “MMA NPA-006” in the said set of drawings; and



7. authorises the erection at the said sites of a traffic sign (hereinafter referred to as “the authorised sign G”) conforming as to size, colour and character with that referenced “MMA NPA-007” in the said set of drawings; and
8. authorises the erection at the said sites of a traffic sign (hereinafter referred to as “the authorised sign H”) conforming as to size, colour and character with that referenced “MMA NPA-008” in the said set of drawings; and
9. authorises the erection at the said sites of a traffic sign (hereinafter referred to as “the authorised sign I”) conforming as to size, colour and character with that referenced “MMA NPA-009” in the said set of drawings; and
10. authorises the erection at the said sites of a traffic sign (hereinafter referred to as “the authorised sign J”) conforming as to size, colour and character with that referenced “MMA NPA-010” in the said set of drawings; and
11. authorises the erection at the said sites of a traffic sign (hereinafter referred to as “the authorised sign K”) conforming as to size, colour and character with that referenced “MMA NPA-011” in the said set of drawings; and
12. authorises the erection at the said sites of a traffic sign (hereinafter referred to as “the authorised sign L”) conforming as to size, colour and character with that referenced “MMA NPA-012” in the said set of drawings; and
13. authorises the erection at the said sites of a traffic sign (hereinafter referred to as “the authorised sign M”) conforming as to size, colour and character with that referenced “MMA NPA-013” in the said set of drawings; and
14. authorises the erection at the said sites of a traffic sign (hereinafter referred to as “the authorised sign N”) conforming as to size, colour and character with that referenced “MMA NPA-014” in the said set of drawings; and



15. authorises the erection at the said sites of a traffic sign (hereinafter referred to as “the authorised sign O”) conforming as to size, colour and character with that referenced “MMA NPA-015” in the said set of drawings; and
16. authorises the erection at the said sites of a traffic sign (hereinafter referred to as “the authorised sign P”) conforming as to size, colour and character with that referenced “MMA NPA-016” in the said set of drawings; and
17. authorises the erection at the said sites of a traffic sign (hereinafter referred to as “the authorised sign Q”) conforming as to size, colour and character with that referenced “MMA NPA-017 (v2)” in the said set of drawings; and
18. directs that the authorised signs A-Q shall only be used to indicate the effect of a corresponding Traffic Regulation Order; and
19. directs, without prejudice to any statutory provision to the like effect, that it is a condition of this authorisation that the erection of the authorised signs A-Q at the said sites shall continue to have effect only until such day as may be appointed by one month’s notice given by the Secretary of State in writing to the traffic authority for the removal or alteration of the authorised signs A-Q and on that day the said authorisation shall, without prejudice to the giving of any further authorisation or direction, cease to have effect.

The provisions of Regulations 7 and 8 of the Traffic Signs Regulations 2016 (Part 1 of S.I. 2012/362, “the 2016 Regulations”) shall apply to the authorised signs A, B, C and D in the same manner as they apply to the sign shown in Schedule 11, Part 2, Item 37 of those Regulations.

The provisions of Regulations 7 and 8 of the 2016 Regulations shall apply to the authorised sign E in the same manner as they apply to the sign shown in Schedule 3, Part 2, Item 36 of those Regulations.



The provisions of Regulations 7 and 8 of the 2016 Regulations shall apply to the authorised signs F, G, H and I in the same manner as they apply to the sign shown in Schedule 9, Part 4, Item 10 of those Regulations.

The provisions of Regulations 7 and 8 of the 2016 Regulations shall apply to the authorised signs J and K in the same manner as they apply to the sign shown in Schedule 11, Part 2, Item 34 of those Regulations.

The provisions of Regulations 7 and 8 of the 2016 Regulations shall apply to the authorised signs L, M and N in the same manner as they apply to the sign shown in Schedule 11, Part 2, Item 36 of those Regulations.

The provisions of Regulations 7 and 8 of the 2016 Regulations shall apply to the authorised O in the same manner as they apply to the sign shown in Schedule 11, Part 2, Item 49 of those Regulations.

The provisions of Regulations 7 and 8 of the 2016 Regulations shall apply to the authorised signs P and Q in the same manner as they apply to the sign shown in Schedule 9, Part 4, Item 8 of those Regulations.

Dated 2nd August 2018

Signed by authority of the Secretary of State

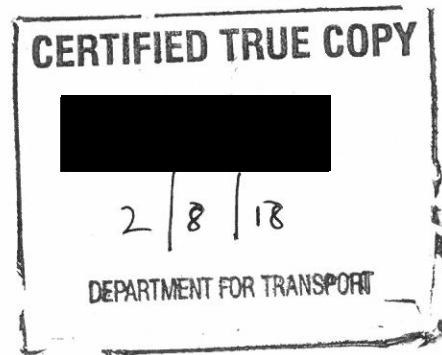
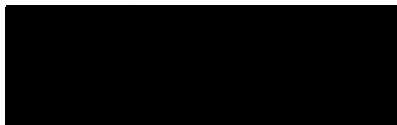

.....
A Delegated Official of the Department for Transport

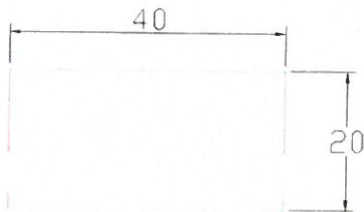
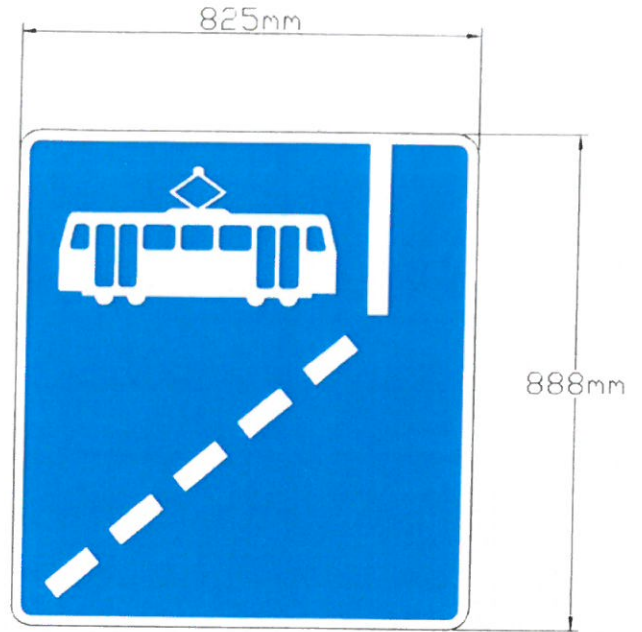
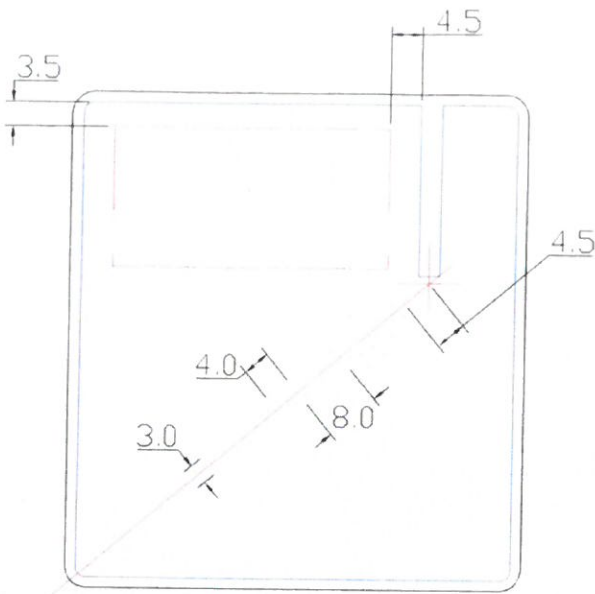

Proposed sign following design rules and corresponding as closely as possible to a sign in TSRGD Schedule 11, Part 2, Item 37 (958).

There is no suitable sign prescribed in TSRGD for the purpose of indicating the beginning of a with-flow lane for use by only trams.

For use in conjunction with line to 1049A where there is insufficient space to accommodate separation islands or to physically segregate a tram only route running parallel to general traffic and therefore it is not possible to sign the tram only section conventionally by using signs to 953.1.

Sign dimensions:
 Width 825mm x Height 888mm
 effective x-height 50mm
 Sign area 0.73m²

Colour:
 White on Blue

Material Class
 R3B (BS EN 12899-1:2007)

Department for Transport

Date: 30 July 2018

No. GT50/152/0016-1



49 Ford Alpha Tower, South Street, Gwent, Newport, NP23 5YU
 Tel: +44 (0)1292 843 8729 www.midlandmetro.co.uk

MMA NPA-001

Scale - 1:12¹/₂

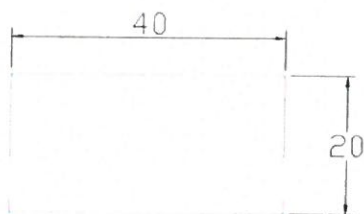
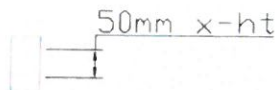
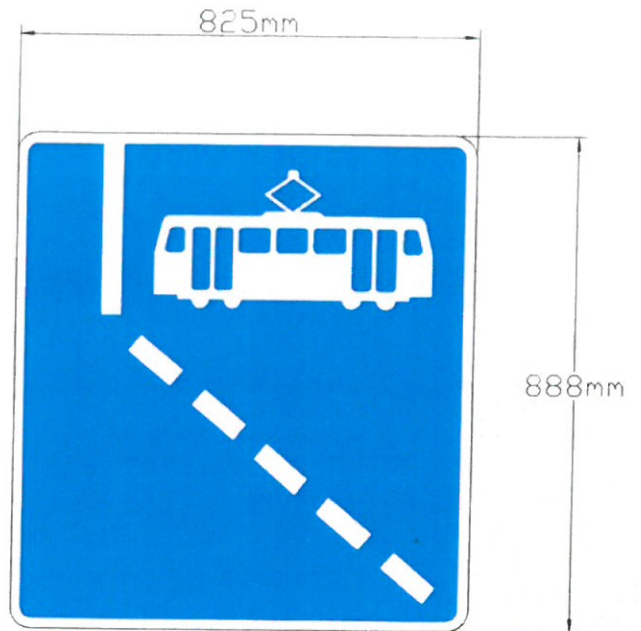
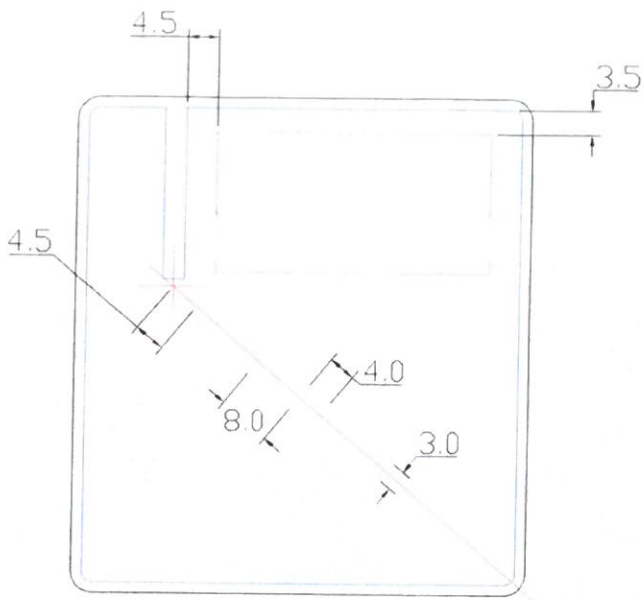

Proposed sign following design rules and corresponding as closely as possible to a sign in TSRGD Schedule 11, Part 2, Item 37 (958).

There is no suitable sign prescribed in TSRGD for the purpose of indicating the beginning of an offside with-flow lane for use by only trams.

For use in conjunction with line to 1049A where there is insufficient space to accommodate separation islands or to physically segregate a tram only route running parallel to general traffic and therefore it is not possible to sign the tram only section conventionally by using signs to 953.1.

Sign dimensions:
Width 825mm x Height 888mm
effective x-height 50mm
Sign area 0.73m²

Colour:
White on Blue

Material Class
R3B (BS EN 12899-1:2007)

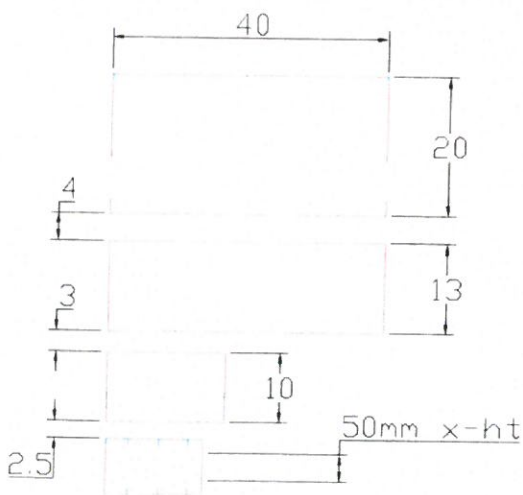
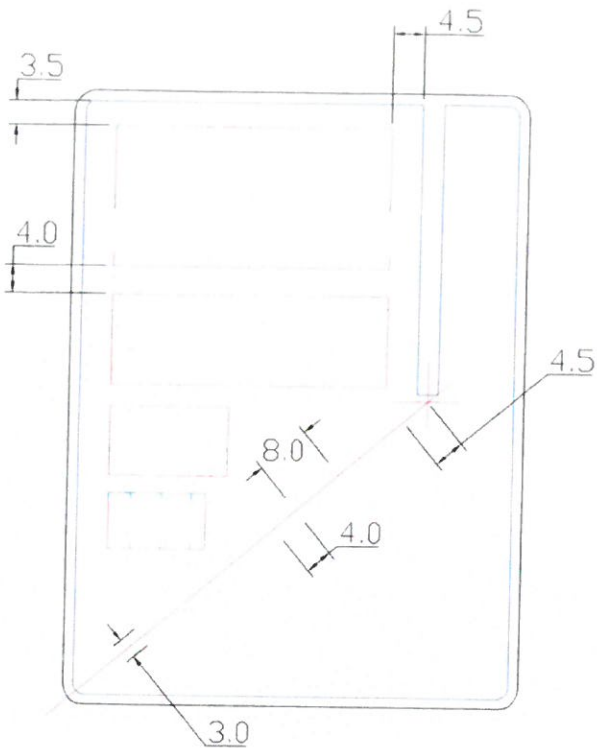

Proposed sign following design rules and corresponding as closely as possible to a sign in TSRGD Schedule 11, Part 2, Item 37 (958).

There is no suitable sign prescribed in TSRGD for the purpose of indicating the beginning of a with-flow lane for use by trams, buses, taxis and cycles.

For use in conjunction with line to 1049A where tram tracks are also laid within a carriageway lane marked as a with-flow lane for buses, taxis, and cycles.

Sign dimensions:
Width 825mm x Height 1100mm
x-height 50mm
Sign area 0.91m²

Colour:
White on Blue, Transport Medium alphabet

Material Class
R3B (BS EN 12899-1:2007)

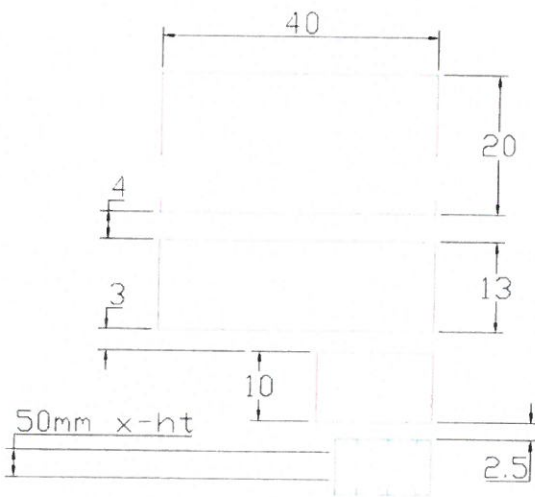
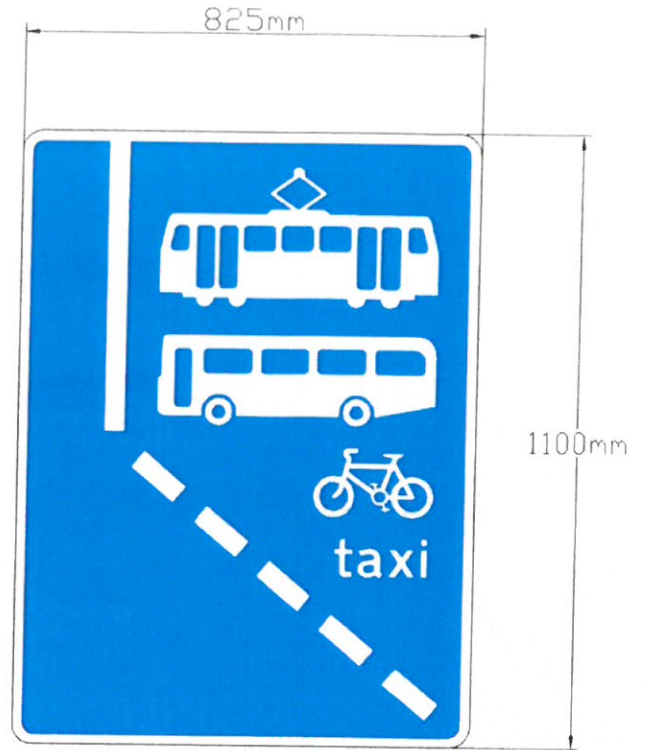
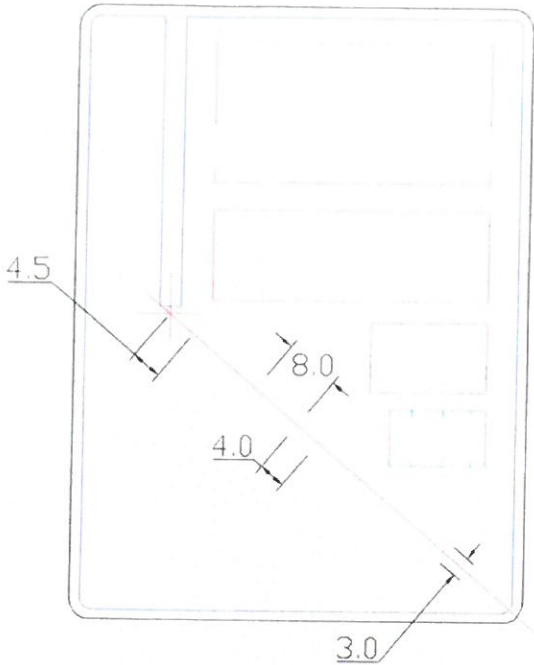

Proposed sign following design rules and corresponding as closely as possible to a sign in TSRGD Schedule 11, Part 2, Item 37 (958).

There is no suitable sign prescribed in TSRGD for the purpose of indicating the beginning of an offside with-flow lane for use by trams, buses, taxis and cycles.

For use in conjunction with line to 1049A where tram tracks are also laid within an offside carriageway lane marked as a with-flow lane for buses, taxis, and cycles.

Sign dimensions:
 Width 825mm x Height 1100mm
 x-height 50mm
 Sign area 0.91m²

Colour:
 White on Blue, Transport Medium alphabet

Material Class
 R3B (BS EN 12899-1:2007)

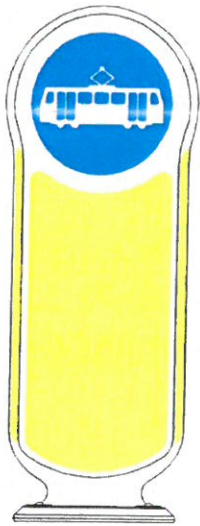
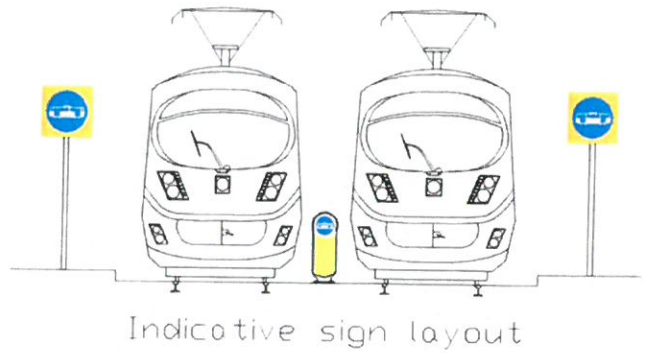
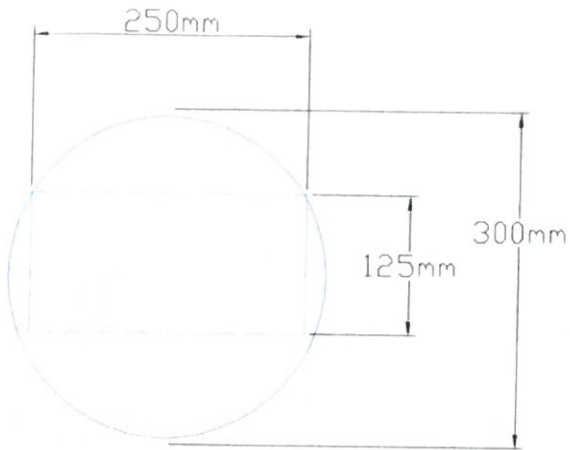

Example bollard

Proposed sign following design rules and corresponding as closely as possible to a sign in TSRGD Schedule 3, Part 2, Item 36 (953.1).

There is no suitable size sign prescribed in TSRGD for the purpose of indicating the beginning of a tram only route by way of being mounted on a self righting non-internally illuminated bollard located between tram lines.

For use where a two-way tram only route commences and a central island of sufficient width to provide full signing is not constructed.

Sign dimensions:
Diameter 300mm
Sign area 0.07m²

Colour:
White on Blue

Material Class
R3B (BS EN 12899-1:2007)

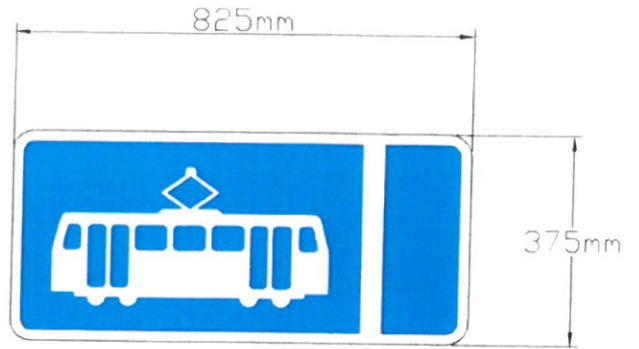
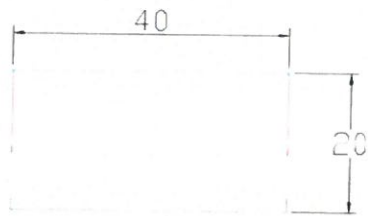
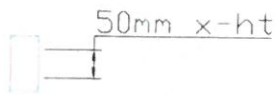
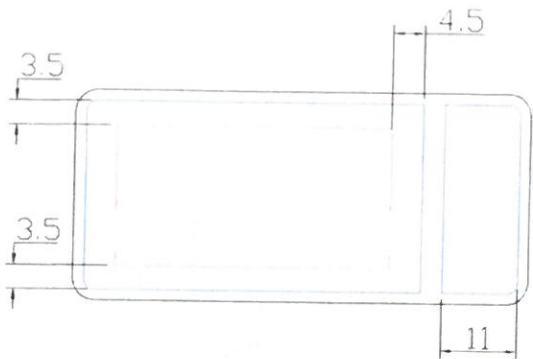

Proposed sign following design rules and corresponding as closely as possible to a sign in TSRGD Schedule 9, Part 4, Item 10 (959B).

There is no suitable sign prescribed in TSRGD for the purpose of indicating a with-flow lane for use by only trams.

For use in conjunction with line to 1049A where there is insufficient space to physically segregate a tram only route running parallel to general traffic.

Sign dimensions:
 Width 825mm x Height 375mm
 effective x-height 50mm
 Sign area 0.31m²

Colour:
 White on Blue

Material Class
 R3B (BS EN 12899-1:2007)

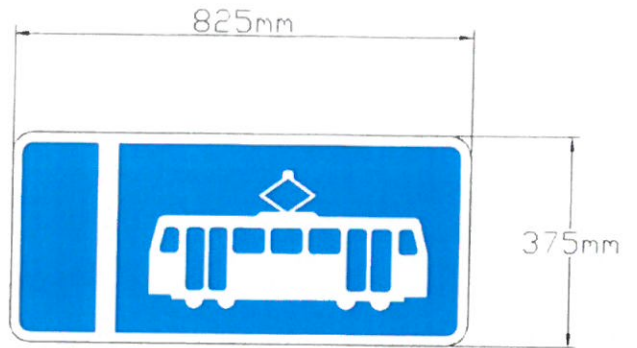
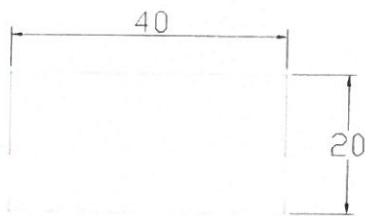
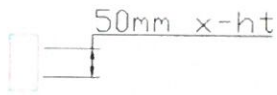
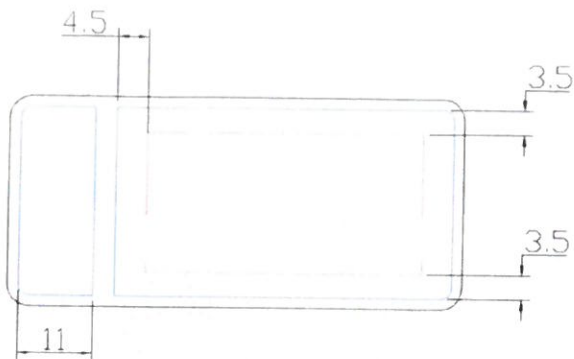

Proposed sign following design rules and corresponding as closely as possible to a sign in TSRGD Schedule 9, Part 4, Item 10 (959B).

There is no suitable sign prescribed in TSRGD for the purpose of indicating an offside with-flow lane for use by only trams.

For use in conjunction with line to 1049A where there is insufficient space to physically segregate a tram only route running parallel to general traffic.

Sign dimensions:
 Width 825mm x Height 375mm
 effective x-height 50mm
 Sign area 0.31m²

Colour:
 White on Blue

Material Class
 R3B (BS EN 12899-1:2007)

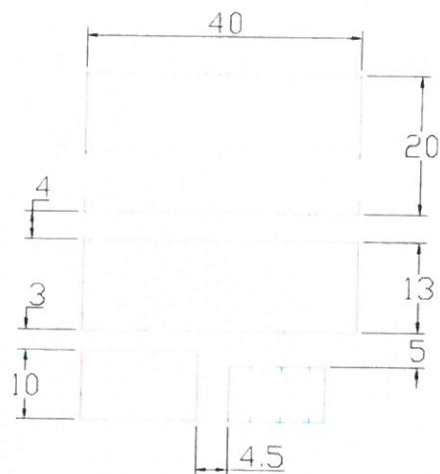
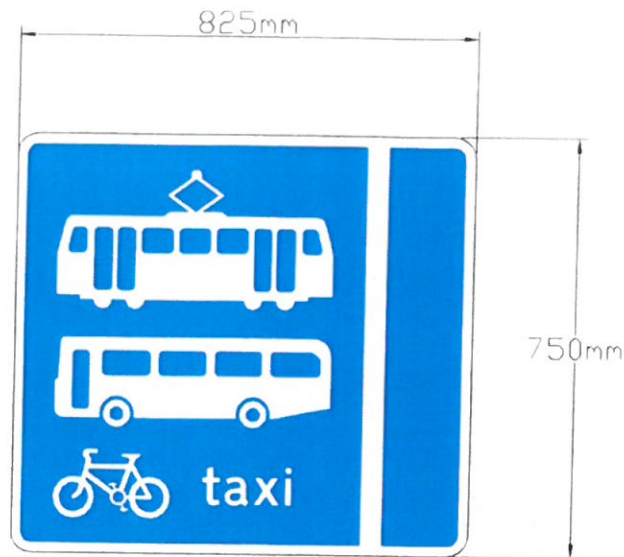
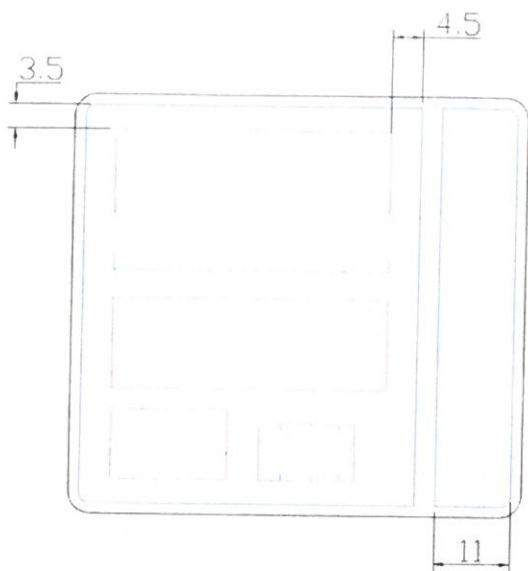

Proposed sign following design rules and corresponding as closely as possible to a sign in TSRGD Schedule 9, Part 4, Item 10 (959B).

There is no suitable sign prescribed in TSRGD for the purpose of indicating a with-flow lane for use by trams, buses, taxis and cycles.

For use in conjunction with line to 1049A where tram tracks are also laid within a carriageway lane marked as a with-flow lane for buses, taxis, and cycles.

Sign dimensions:
 Width 825mm x Height 750mm
 effective x-height 50mm
 Sign area 0.62m²

Colour:
 White on Blue, Transport Medium alphabet

Material Class
 R3B (BS EN 12899-1:2007)

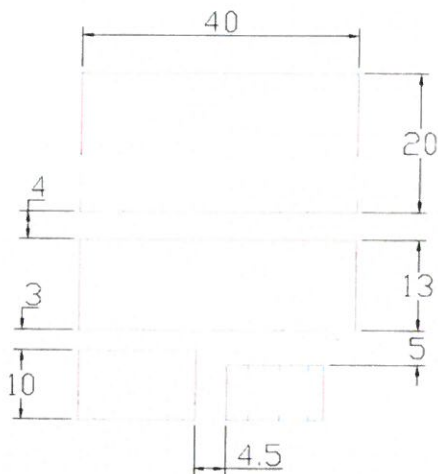
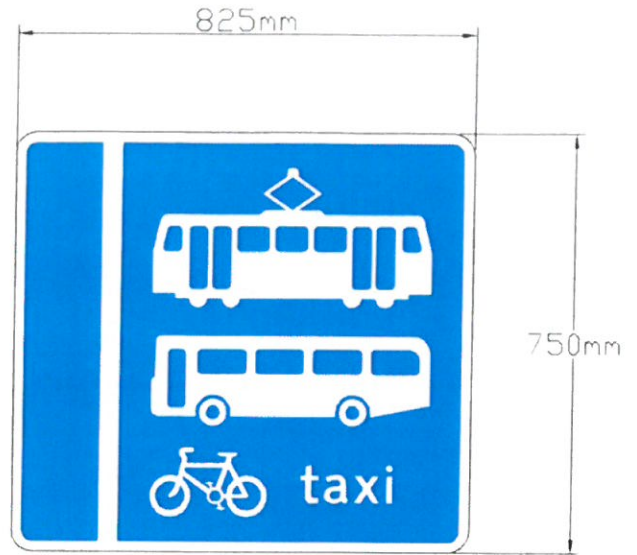
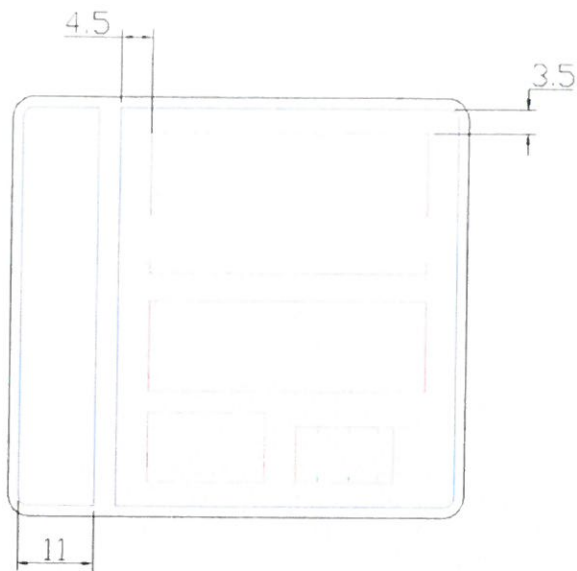

Proposed sign following design rules and corresponding as closely as possible to a sign in TSRGD Schedule 9, Part 4, Item 10 (959B).

There is no suitable sign prescribed in TSRGD for the purpose of indicating an offside with-flow lane for use by trams, buses, taxis and cycles.

For use in conjunction with line to 1049A where tram tracks are also laid within an offside carriageway lane marked as a with-flow lane for buses, taxis, and cycles.

Sign dimensions:
 Width 825mm x Height 750mm
 effective x-height 50mm
 Sign area 0.62m²

Colour:
 White on Blue, Transport Medium alphabet

Material Class
 R3B (BS EN 12899-1:2007)

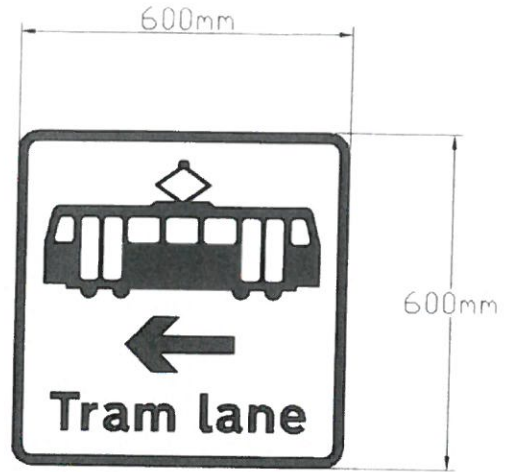
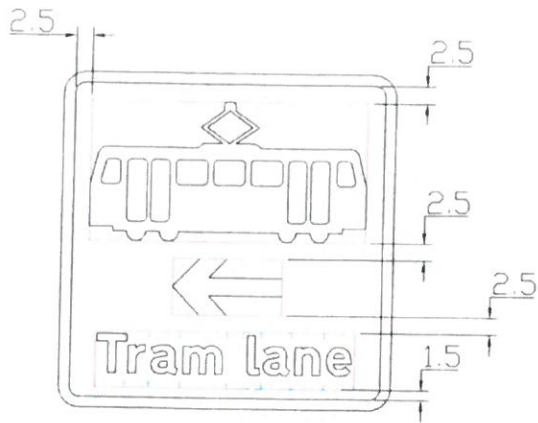

Tram 50mm x-ht

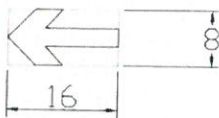
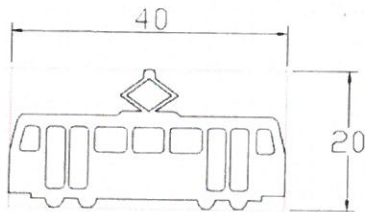

Proposed sign following design rules and corresponding as closely as possible to a sign in TSRGD Schedule 11, Part 2, Item 34 (962).

There is no suitable sign prescribed in TSRGD for the purpose of indicating a tram lane at a junction ahead.

For use on the minor arm of a T-junction to indicate the presence of a with-flow tram only lane on the same side of the main route.

Sign dimensions:
 Width 600mm x Height 600mm
 x-height 50mm
 Sign area 0.36m²

Colour:
 Black on White, Transport Heavy alphabet

Material Class
 R3B (BS EN 12899-1:2007)

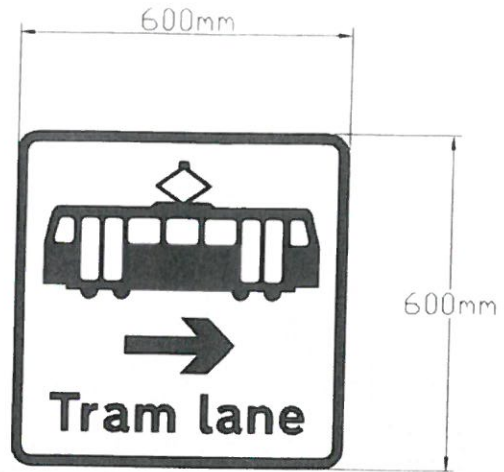
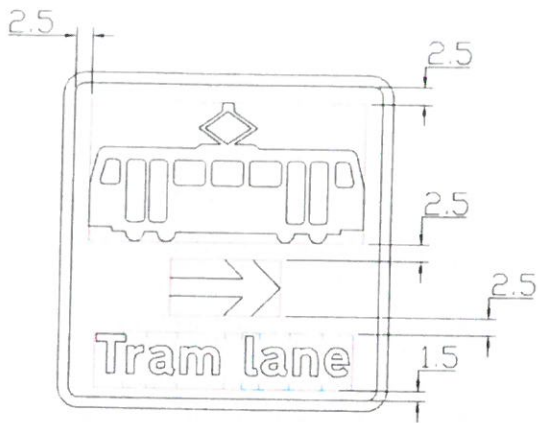

Tram 50mm x-height

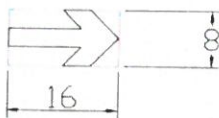
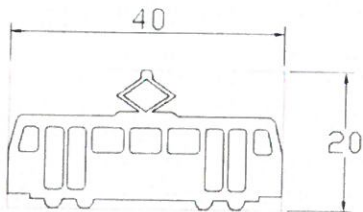

Proposed sign following design rules and corresponding as closely as possible to a sign in TSRGD Schedule 11, Part 2, Item 34 (962).

There is no suitable sign prescribed in TSRGD for the purpose of indicating a tram lane at a junction ahead.

For use on the minor arm of a T-junction to indicate the presence of a with-flow tram only lane on the opposite side of the main route.

Sign dimensions:
 Width 600mm x Height 600mm
 x-height 50mm
 Sign area 0.36m²

Colour:
 Black on White, Transport Heavy alphabet

Material Class
 R3B (BS EN 12899-1:2007)



Tram 50mm x-ht

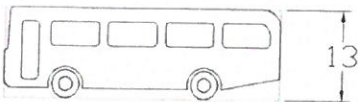
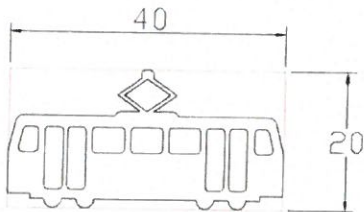

Proposed sign following design rules and corresponding as closely as possible to a sign in TSRGD Schedule 11, Part 2, Item 36 (962.2).

There is no suitable sign prescribed in TSRGD for the purpose of indicating bus and tram lanes at a junction ahead.

For use on the minor arm of a T-junction to indicate the presence of with-flow tram only lanes on both sides of the main route.

Sign dimensions:
 Width 600mm x Height 900mm
 x-height 50mm
 Sign area 0.54m²

Colour:
 Black on White, Transport Heavy alphabet

Material Class
 R3B (BS EN 12899-1:2007)

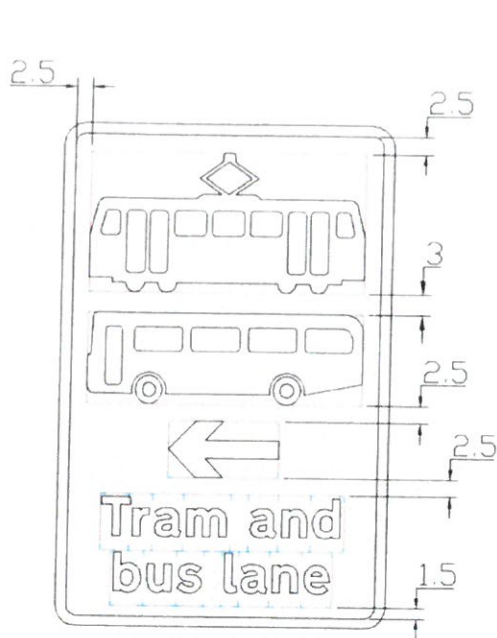

Tram $50\text{mm} \times \text{ht}$

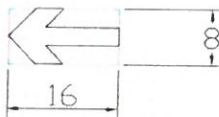
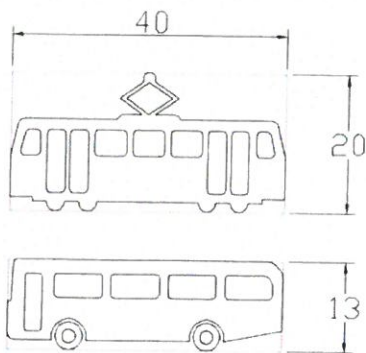

Proposed sign following design rules and corresponding as closely as possible to a sign in TSRGD Schedule 11, Part 2, Item 36 (962.2).

There is no suitable sign prescribed in TSRGD for the purpose of indicating a bus and tram lane at a junction ahead.

For use on the minor arm of a T-junction to indicate where tram tracks are also laid within a carriageway lane marked as a with-flow lane for buses, taxis, and cycles on the same side of the main route.

Sign dimensions:
Width 600mm x Height 900mm
x-height 50mm
Sign area 0.54m²

Colour:
Black on White, Transport Heavy alphabet

Material Class
R3B (BS EN 12899-1:2007)

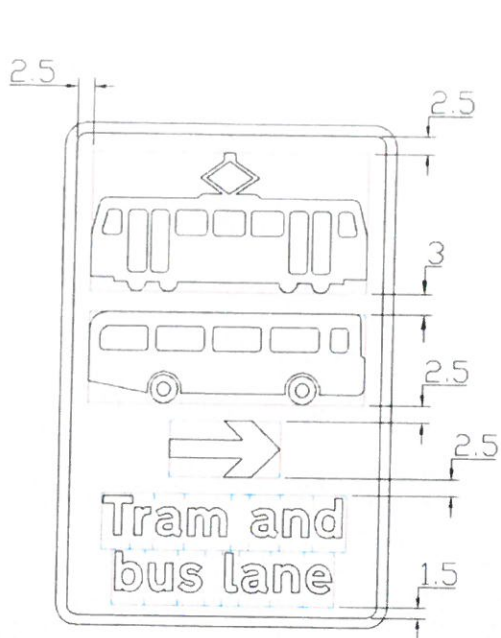

Tram $50\text{mm} \times \text{h-t}$

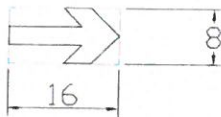
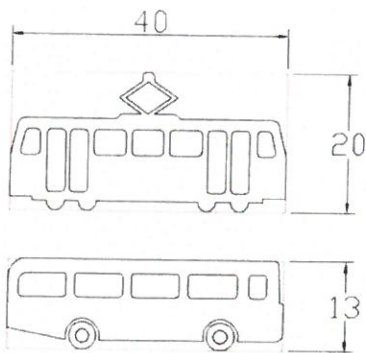

Proposed sign following design rules and corresponding as closely as possible to a sign in TSRGD Schedule 11, Part 2, Item 36 (962.2).

There is no suitable sign prescribed in TSRGD for the purpose of indicating a bus and tram lane at a junction ahead.

For use on the minor arm of a T-junction to indicate where tram tracks are also laid within a carriageway lane marked as a with-flow lane for buses, taxis, and cycles on the opposite side of the main route.

Sign dimensions:
Width 600mm x Height 900mm
x-height 50mm
Sign area 0.54m²

Colour:
Black on White, Transport Heavy alphabet

Material Class
R3B (BS EN 12899-1:2007)

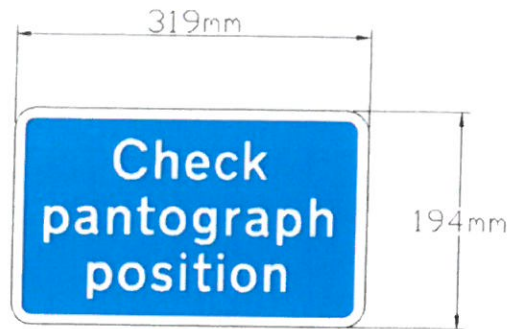
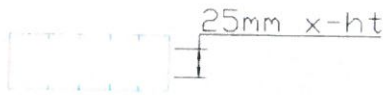
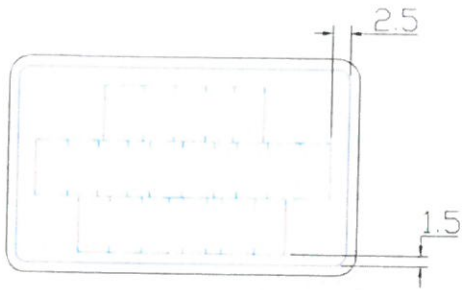

Proposed sign following design rules and corresponding as closely as possible to a sign in TSRGD Schedule 11, Part 2, Item 49 (2934).

There is no suitable sign size, legend variant, or x-height prescribed in TSRGD.

For use at a tram stop to remind tram vehicle drivers to check the pantograph position at the transition from overhead power supply to battery power, or vice versa. Sign intended to be visible whilst the tram is stationary.

Sign dimensions:
 Width 319mm x Height 194mm
 x-height 25mm
 Sign area 0.06m²

Colour:
 White on Blue, Transport Medium alphabet

Material Class
 RA2 (BS EN 12899-1:2007)

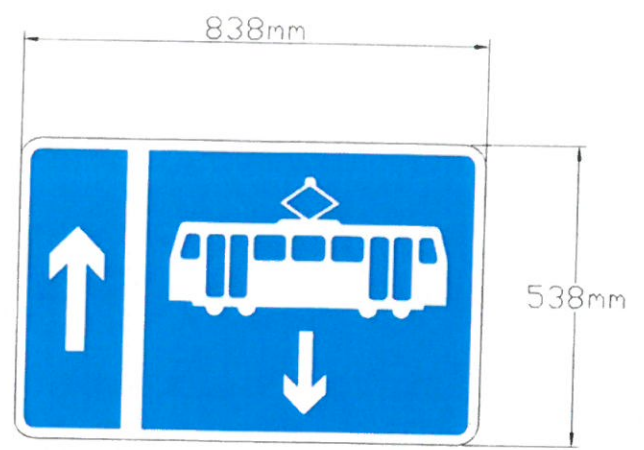
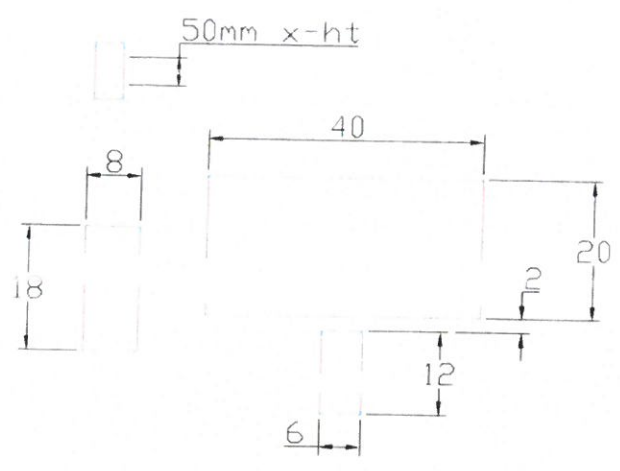
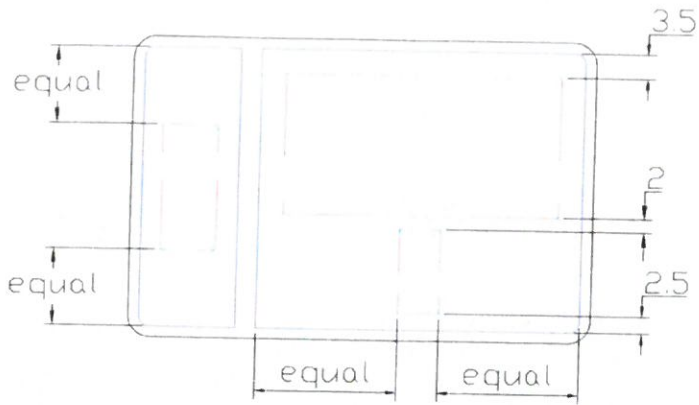

Proposed sign following design rules and corresponding as closely as possible to a sign in TSRGD Schedule 9, Part 4, Item 8 (960).

There is no suitable sign prescribed in TSRGD for the purpose of indicating a one-way road with a contraflow tram lane.

For use where tram tracks are laid within a carriageway lane operating in contraflow to general traffic, separated with road marking to 1049A, and where there is insufficient space to accommodate separation islands or to physically segregate the tram only route.

Sign dimensions:
 Width 838mm x Height 538mm
 effective x-height 50mm
 Sign area 0.45m²

Colour:
 White on Blue

Material Class
 R3B (BS EN 12899-1:2007)

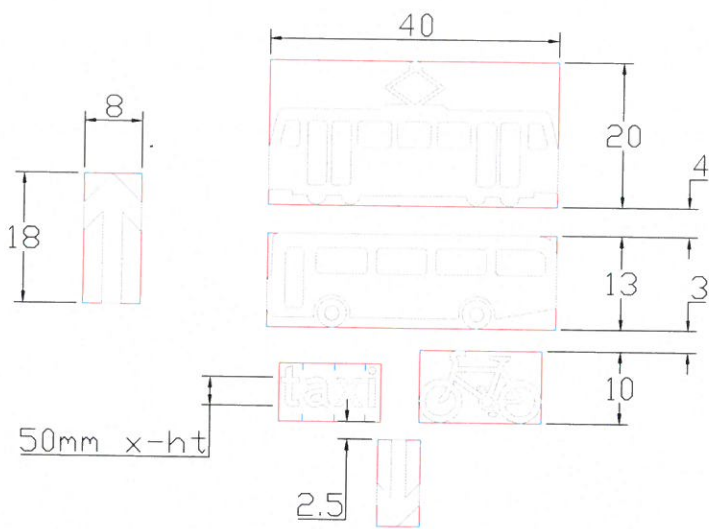
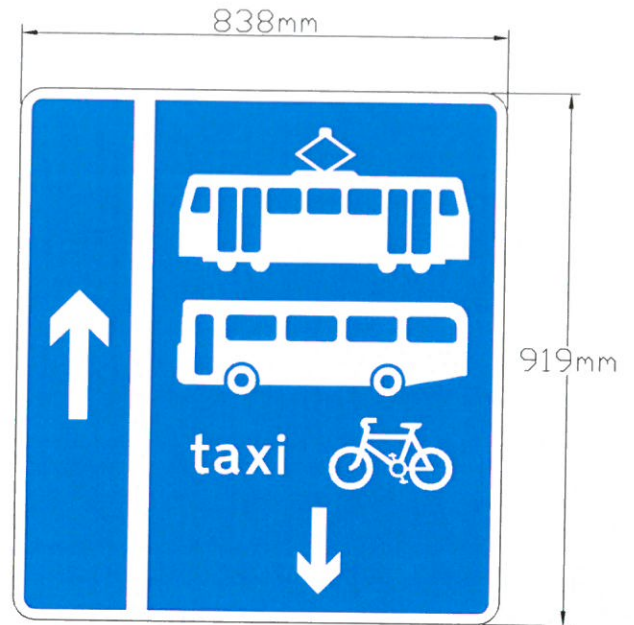
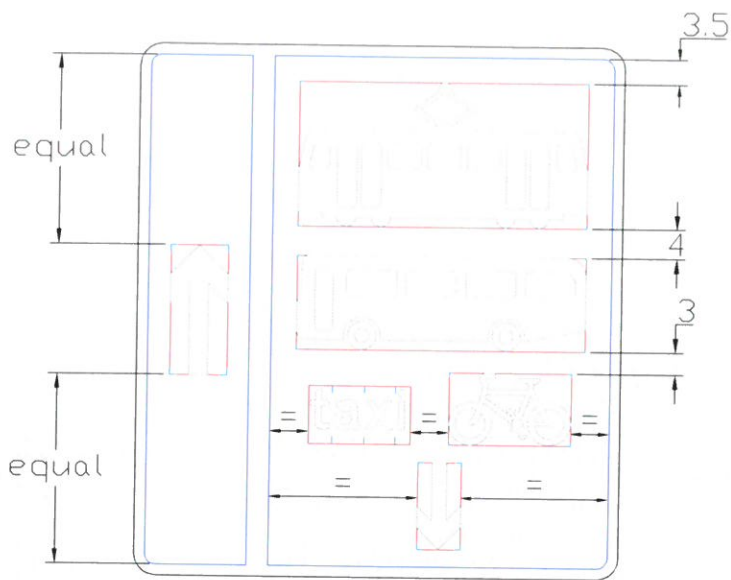

Proposed sign following design rules and corresponding as closely as possible to a sign in TSRGD Schedule 9, Part 4, Item 8 (960).

There is no suitable sign prescribed in TSRGD for the purpose of indicating a one-way road with contraflow lane used for trams, buses, taxis and cycles.

For use where tram tracks are also laid within a carriageway lane operating in contra flow to general traffic, separated with road marking to 1049A, for buses, taxis, and cycles.

Sign dimensions:
Width 838mm x Height 919mm
effective x-height 50mm (effective)
Sign area 0.77m²

Colour:
White on Blue, Transport Medium alphabet

Material Class
R3B (BS EN 12899-1:2007)