



Department  
for Transport

## Road Traffic Regulation Act 1984 Sections 64 and 65

### Authorisation of traffic signs and special directions

#### Accessible transcript

Secretary of State for Transport's traffic authorisation of traffic signs to inform drivers of a "Clean Air Zone"; an area in respect of which charges are imposed for the keeping or use of motor vehicles not meeting certain emission standards pursuant to a Scheme. "Scheme" means a scheme for imposing charges made in respect of keeping or use of certain motor vehicles not meeting certain emission standards, made by North Somerset County Council pursuant to Part III and Schedule 12 of the Transport Act 2000.

The following pages contain a copy of the text from the Secretary of State for Transport's traffic authorisation regarding the above traffic signs.

A scanned copy of the signed authorisation and supporting documents from the application are appended to this letter. The supporting material is submitted to the Department for Transport by a third party. You should refer to the party involved for accessible copies of the supporting material.



**ROAD TRAFFIC REGULATION ACT 1984 – SECTIONS 64 AND 65  
AUTHORISATION OF TRAFFIC SIGNS AND SPECIAL DIRECTIONS**

The Secretary of State for Transport in exercise of powers under Sections 64 and 65 of the Road Traffic Regulation Act 1984, and of all other powers enabling him in that behalf, hereby gives the authorisation contained in paragraphs 2 and 3 of this Instrument and the directions contained in paragraph 4 of this Instrument.

1. In this Instrument –

“Authorised sign” means a traffic sign whose placing on roads is authorised by paragraph 2;

“the Clean Air Zone” means the area in respect of which charges are imposed for the keeping or use of motor vehicles not meeting certain emission standards pursuant to a Scheme;

“Scheme” means a scheme for imposing charges made in respect of keeping or use of certain motor vehicles not meeting certain emission standards, made by North Somerset County Council pursuant to Part III and Schedule 12 of the Transport Act 2000, Parts 2 and 6 of The Road User Charging Schemes (Penalty Charges, Adjudication and Enforcement) (England) Regulations 2013 and of all other powers enabling it in that behalf;

“the 2016 Regulations” means the Traffic Signs Regulations and General Directions 2016 (Part 1 of S.I. 2016/362).



2. The Secretary of State hereby:-

- (1) authorises the erection at appropriate sites on or near any road for which North Somerset County Council is the traffic authority of a traffic sign (hereinafter referred to as “the authorised sign NP 677.1”) conforming as to size, colour and character with that referenced NP 677.1 in the attached set of drawings save that (i) the reference to the times of operation may be varied or omitted; (ii) the x-height may be varied as indicated; (iii) the name of the traffic authority in the upper panel may be varied as appropriate; (iv) the logo of the traffic authority in the upper panel may be omitted; and (v) the alphabet indicating the class on the Clean Air Zone symbol may be varied to one shown on the attached drawing referenced S 68; and
  
- (2) authorises the erection at the said sites of a traffic sign (hereinafter referred to as “the authorised sign NP 818.8”) conforming as to size, colour and character with that referenced NP 818.8 in the said set of drawings save that (i) the reference to the times of operation may be varied or omitted; (ii) the x-height may be varied as indicated; (iii) the distance may be varied; (iv) “ahead” may be placed centrally below the distance; (v) “ahead” may be omitted and an arrow pointing horizontally to the left or to the right placed centrally below the distance; (vi) the legend above the Clean Air Zone symbol indicating the distance to the zone may be varied as appropriate; (viii) the Clean Air Zone symbol in the top panel of the sign illustrated on sheet 1 of the said drawing may be placed to the right of the legend in that panel; and (ix) the alphabet indicating the class on the Clean Air Zone symbol may be varied to one shown on the attached drawing referenced S 68; and
  
- (3) authorises the erection at the said sites of a traffic sign (hereinafter referred to as “the authorised sign NP 894.1”) conforming as to size, colour and character with that referenced NP 894.1 in the said set of drawings save that (i) the Clean Air Zone symbol may be placed to the left of the camera symbol; (ii) the x-height may



be varied as indicated; and (iii) a panel may be added above the current panel giving the name, and any logo, of the enforcement authority; and

- (4) authorises the erection at the said sites of a traffic sign (hereinafter referred to as “the authorised sign NP 664.4”) conforming as to size, colour and character with that referenced NP 664.4 in the said set of drawings save that (i) the x-height may be varied as indicated; and (ii) the bottom panel may be placed to the right of the top panel; and
- (5) authorises the erection at the said sites of a traffic sign (hereinafter referred to as “the authorised sign E”) conforming as to colour and character with that referenced “Sign E” in the said set of drawings save that (i) the reference to the times of operation may be varied or omitted; (ii) the reference to the date may be varied or omitted; (iii) the reference in the top panel to the city may be omitted or varied to the name of a council, city or county; (iv) the legend “BOUNDARY” in the top panel may be omitted; (v) panels may be omitted or added; (vi) panel dividers may be omitted; (vii) a distance with or without an arrow pointing to the left or to the right may be added; (viii) an arrow pointing to the left or to the right may be added; and (ix) the legends shown in the respective panels may be displayed on variable message signs as defined in Schedule 1 of the 2016 Regulations; and
- (6) directs that the Clean Air Zone symbol shown in the said set of drawings (hereinafter referred to as “the authorised symbol S 68”) conforming as to size, colour and character with that referenced S 68 in the said set of drawings may be placed on any appropriate sign in Schedule 12 of the 2016 Regulations in the same manner as the symbols mentioned in Schedule 12, Parts 11 and 20 to those Regulations; and
- (7) authorises the erection at the said sites of a traffic sign (hereinafter referred to as “the direction sign”) conforming to the sign shown in Schedule 12, Part 28, Item 22 (diagram 818.4) of the 2016 Regulations, save that (i) the authorised symbol S 68 in the said set of drawings may replace the “weight limit” symbol; (ii) the size



of the authorised symbol S 68 may be varied as indicated; (iii) the legend above the “weight limit” symbol may be varied as appropriate or omitted; and (iv) a symbol from Schedule 12, Parts 5 or 7 of the 2016 Regulations may be added to the direction sign; and

(8) authorises the display of the authorised sign NP 677.1, the authorised sign NP 818.8, the authorised sign NP 894.1, the authorised sign NP 664.4, the authorised sign E, the direction sign and signs incorporating the authorised symbol S 68, on variable message signs as defined in Schedule 1 of the 2016 Regulations; and

(9) directs that the variants shown in column 4 of the sign to Schedule 12, Part 28, Item 22 (diagram 818.4) of the 2016 Regulations shall apply to the direction sign.

### 3.

(1) The provisions of Regulations 5, 7, 8 and 11 of the 2016 Regulations shall apply to the authorised sign NP 677.1 as they do to the sign shown in Item 1 of the sign table in Schedule 8, Part 4 (diagram 677) to those Regulations.

(2) The provisions of Regulations 5, 7, 8 and 11 of the 2016 Regulations shall apply to the authorised sign NP 818.8 as they do to the sign shown in Item 3 of the sign table in Schedule 8, Part 4 (diagram 818.6) to those Regulations.

(3) The provisions of Regulations 5, 7, 8 and 11 of the 2016 Regulations shall apply to the authorised sign NP 894.1 as they do to the sign shown in Item 5 of the sign table in Schedule 8, Part 4 (diagram 894) to those Regulations.

(4) The provisions of Regulations 5, 7, 8 and 11 of the 2016 Regulations shall apply to the authorised sign NP 664.4 as they do to the sign shown in Item 1 of the sign table in Schedule 7, Part 2 (diagram 664) to those Regulations.



- (5) The provisions of Regulations 5, 7, 8 and 11 of the 2016 Regulations shall apply to the authorised symbol S 68 as they do to the symbol shown in Item 19 of the sign table in Schedule 12, Part 11 to those Regulations.
- (6) The provisions of Regulations 5, 7, 8 and 11 of the 2016 Regulations shall apply to the authorised sign E as they do to the sign shown in Item 37 of the sign table in Schedule 13, Part 6 (diagram 7014) to those Regulations.
- (7) The provisions of Regulations 5, 7, 8 and 11 of the 2016 Regulations shall apply to the direction sign as they do to the sign shown in Item 22 of the sign table in Schedule 12, Part 28 (diagram 818.4) to those Regulations.
- (8) The provisions of Schedule 12, Parts 1 to 29 of the 2016 Regulations shall apply to the direction sign in the same manner as they apply to the signs shown in Schedule 12, Part 2 of those Regulations.

4. The Secretary of State hereby directs that –

- (1) Without prejudice to any regulations made under paragraph 22 (1) (e) of Schedule 9 to the Road Traffic Regulation Act 1984; the authorised sign NP 677.1 shall be placed on or near any road for which North Somerset County Council is the traffic authority, in sufficient numbers and in appropriate positions to indicate to all traffic the entrance to the Clean Air Zone and the nature of the provisions of a Scheme.
- (2) Without prejudice to any regulations made under paragraph 22 (1) (e) of Schedule 9 to the Road Traffic Regulation Act 1984; the authorised sign NP 818.8 or signs incorporating the authorised symbol S 68 may be placed on or near any road for which North Somerset County Council is the traffic authority, in sufficient numbers and in appropriate positions to provide advance indication to all traffic of the Clean Air Zone and the nature of the provisions of a Scheme.



- (3) Without prejudice to any regulations made under paragraph 22 (1) (e) of Schedule 9 to the Road Traffic Regulation Act 1984; the authorised sign NP 894.1 may be placed on or near any road for which North Somerset County Council is the traffic authority, in sufficient numbers and in appropriate positions as a reminder to all traffic within the Clean Air Zone in which cameras are used to enforce traffic regulations.
- (4) Without prejudice to any regulations made under paragraph 22 (1) (e) of Schedule 9 to the Road Traffic Regulation Act 1984; the authorised sign NP 664.4 shall be placed on or near any road for which North Somerset County Council is the traffic authority, in sufficient numbers and in appropriate positions to indicate to all traffic the end of the Clean Air Zone.
- (5) Without prejudice to any regulations made under paragraph 22 (1) (e) of Schedule 9 to the Road Traffic Regulation Act 1984; the authorised sign E shall be placed on or near any road for which North Somerset County Council is the traffic authority, in sufficient numbers and in appropriate positions to indicate to all traffic information pertaining to the introduction of the Clean Air Zone and the nature of the provisions of a Scheme.
- (6) Without prejudice to any regulations made under paragraph 22 (1) (e) of Schedule 9 to the Road Traffic Regulation Act 1984; the direction sign incorporating the authorised symbol S 68 may be placed on or near any road for which North Somerset County Council is the traffic authority, in sufficient numbers and in appropriate positions to provide advance indication to all traffic of the Clean Air Zone and the nature of the provisions of a Scheme.
- (7) The authorised sign NP 677.1, the authorised sign NP 818.8, the authorised sign NP 894.1, the authorised sign NP 664.4, the authorised sign E, the direction sign and the authorised symbol S 68 when incorporated on signs, may be placed only as appropriate to indicate the provisions of a Scheme.



(8) It is a condition of this authorisation that the authorised sign NP 677.1 and the authorised sign NP 664.4 may only be placed to indicate the effect of an Act, order, regulation, bylaw, resolution or notice which restricts or prohibits the use of the road by traffic; and

(9) Without prejudice to any statutory provision to the like effect, it is a condition of this authorisation that the placing of the authorised sign NP 677.1, the authorised sign NP 818.8, the authorised sign NP 894.1, the authorised sign NP 664.4, the authorised sign E, the direction sign and signs incorporating the authorised symbol S 68 on or near the said roads shall continue to have effect only until such day as may be appointed by one month's notice given by the Secretary of State in writing to the traffic authority for the removal or alteration of the authorised signs, and on that day the said authorisation shall, without prejudice to the giving of any further authorisation or direction, cease to have effect.

Dated: *30 March 2022*

Signed by authority of the Secretary of State

.....

A Delegated Official of the Department for Transport





Department  
for Transport

**SCANNED  
AUTHORISATION  
AND SUPPORTING  
DOCUMENTS  
FOLLOW**



**ROAD TRAFFIC REGULATION ACT 1984 – SECTIONS 64 AND 65  
AUTHORISATION OF TRAFFIC SIGNS AND SPECIAL DIRECTIONS**

The Secretary of State for Transport in exercise of powers under Sections 64 and 65 of the Road Traffic Regulation Act 1984, and of all other powers enabling him in that behalf, hereby gives the authorisation contained in paragraphs 2 and 3 of this Instrument and the directions contained in paragraph 4 of this Instrument.

1. In this Instrument –

“Authorised sign” means a traffic sign whose placing on roads is authorised by paragraph 2;

“the Clean Air Zone” means the area in respect of which charges are imposed for the keeping or use of motor vehicles not meeting certain emission standards pursuant to a Scheme;

“Scheme” means a scheme for imposing charges made in respect of keeping or use of certain motor vehicles not meeting certain emission standards, made by North Somerset County Council pursuant to Part III and Schedule 12 of the Transport Act 2000, Parts 2 and 6 of The Road User Charging Schemes (Penalty Charges, Adjudication and Enforcement) (England) Regulations 2013 and of all other powers enabling it in that behalf;

“the 2016 Regulations” means the Traffic Signs Regulations and General Directions 2016 (Part 1 of S.I. 2016/362).



2. The Secretary of State hereby:-

- (1) authorises the erection at appropriate sites on or near any road for which North Somerset County Council is the traffic authority of a traffic sign (hereinafter referred to as “the authorised sign NP 677.1”) conforming as to size, colour and character with that referenced NP 677.1 in the attached set of drawings save that (i) the reference to the times of operation may be varied or omitted; (ii) the x-height may be varied as indicated; (iii) the name of the traffic authority in the upper panel may be varied as appropriate; (iv) the logo of the traffic authority in the upper panel may be omitted; and (v) the alphabet indicating the class on the Clean Air Zone symbol may be varied to one shown on the attached drawing referenced S 68; and
- (2) authorises the erection at the said sites of a traffic sign (hereinafter referred to as “the authorised sign NP 818.8”) conforming as to size, colour and character with that referenced NP 818.8 in the said set of drawings save that (i) the reference to the times of operation may be varied or omitted; (ii) the x-height may be varied as indicated; (iii) the distance may be varied; (iv) “ahead” may be placed centrally below the distance; (v) “ahead” may be omitted and an arrow pointing horizontally to the left or to the right placed centrally below the distance; (vi) the legend above the Clean Air Zone symbol indicating the distance to the zone may be varied as appropriate; (viii) the Clean Air Zone symbol in the top panel of the sign illustrated on sheet 1 of the said drawing may be placed to the right of the legend in that panel; and (ix) the alphabet indicating the class on the Clean Air Zone symbol may be varied to one shown on the attached drawing referenced S 68; and
- (3) authorises the erection at the said sites of a traffic sign (hereinafter referred to as “the authorised sign NP 894.1”) conforming as to size, colour and character with that referenced NP 894.1 in the said set of drawings save that (i) the Clean Air Zone symbol may be placed to the left of the camera symbol; (ii) the x-height may



be varied as indicated; and (iii) a panel may be added above the current panel giving the name, and any logo, of the enforcement authority; and

- (4) authorises the erection at the said sites of a traffic sign (hereinafter referred to as “the authorised sign NP 664.4”) conforming as to size, colour and character with that referenced NP 664.4 in the said set of drawings save that (i) the x-height may be varied as indicated; and (ii) the bottom panel may be placed to the right of the top panel; and
- (5) authorises the erection at the said sites of a traffic sign (hereinafter referred to as “the authorised sign E”) conforming as to colour and character with that referenced “Sign E” in the said set of drawings save that (i) the reference to the times of operation may be varied or omitted; (ii) the reference to the date may be varied or omitted; (iii) the reference in the top panel to the city may be omitted or varied to the name of a council, city or county; (iv) the legend “BOUNDARY” in the top panel may be omitted; (v) panels may be omitted or added; (vi) panel dividers may be omitted; (vii) a distance with or without an arrow pointing to the left or to the right may be added; (viii) an arrow pointing to the left or to the right may be added; and (ix) the legends shown in the respective panels may be displayed on variable message signs as defined in Schedule 1 of the 2016 Regulations; and
- (6) directs that the Clean Air Zone symbol shown in the said set of drawings (hereinafter referred to as “the authorised symbol S 68”) conforming as to size, colour and character with that referenced S 68 in the said set of drawings may be placed on any appropriate sign in Schedule 12 of the 2016 Regulations in the same manner as the symbols mentioned in Schedule 12, Parts 11 and 20 to those Regulations; and
- (7) authorises the erection at the said sites of a traffic sign (hereinafter referred to as “the direction sign”) conforming to the sign shown in Schedule 12, Part 28, Item 22 (diagram 818.4) of the 2016 Regulations, save that (i) the authorised symbol S 68 in the said set of drawings may replace the “weight limit” symbol; (ii) the size



of the authorised symbol S 68 may be varied as indicated; (iii) the legend above the “weight limit” symbol may be varied as appropriate or omitted; and (iv) a symbol from Schedule 12, Parts 5 or 7 of the 2016 Regulations may be added to the direction sign; and

(8) authorises the display of the authorised sign NP 677.1, the authorised sign NP 818.8, the authorised sign NP 894.1, the authorised sign NP 664.4, the authorised sign E, the direction sign and signs incorporating the authorised symbol S 68, on variable message signs as defined in Schedule 1 of the 2016 Regulations; and

(9) directs that the variants shown in column 4 of the sign to Schedule 12, Part 28, Item 22 (diagram 818.4) of the 2016 Regulations shall apply to the direction sign.

### 3.

(1) The provisions of Regulations 5, 7, 8 and 11 of the 2016 Regulations shall apply to the authorised sign NP 677.1 as they do to the sign shown in Item 1 of the sign table in Schedule 8, Part 4 (diagram 677) to those Regulations.

(2) The provisions of Regulations 5, 7, 8 and 11 of the 2016 Regulations shall apply to the authorised sign NP 818.8 as they do to the sign shown in Item 3 of the sign table in Schedule 8, Part 4 (diagram 818.6) to those Regulations.

(3) The provisions of Regulations 5, 7, 8 and 11 of the 2016 Regulations shall apply to the authorised sign NP 894.1 as they do to the sign shown in Item 5 of the sign table in Schedule 8, Part 4 (diagram 894) to those Regulations.

(4) The provisions of Regulations 5, 7, 8 and 11 of the 2016 Regulations shall apply to the authorised sign NP 664.4 as they do to the sign shown in Item 1 of the sign table in Schedule 7, Part 2 (diagram 664) to those Regulations.



- (5) The provisions of Regulations 5, 7, 8 and 11 of the 2016 Regulations shall apply to the authorised symbol S 68 as they do to the symbol shown in Item 19 of the sign table in Schedule 12, Part 11 to those Regulations.
- (6) The provisions of Regulations 5, 7, 8 and 11 of the 2016 Regulations shall apply to the authorised sign E as they do to the sign shown in Item 37 of the sign table in Schedule 13, Part 6 (diagram 7014) to those Regulations.
- (7) The provisions of Regulations 5, 7, 8 and 11 of the 2016 Regulations shall apply to the direction sign as they do to the sign shown in Item 22 of the sign table in Schedule 12, Part 28 (diagram 818.4) to those Regulations.
- (8) The provisions of Schedule 12, Parts 1 to 29 of the 2016 Regulations shall apply to the direction sign in the same manner as they apply to the signs shown in Schedule 12, Part 2 of those Regulations.

4. The Secretary of State hereby directs that –

- (1) Without prejudice to any regulations made under paragraph 22 (1) (e) of Schedule 9 to the Road Traffic Regulation Act 1984; the authorised sign NP 677.1 shall be placed on or near any road for which North Somerset County Council is the traffic authority, in sufficient numbers and in appropriate positions to indicate to all traffic the entrance to the Clean Air Zone and the nature of the provisions of a Scheme.
- (2) Without prejudice to any regulations made under paragraph 22 (1) (e) of Schedule 9 to the Road Traffic Regulation Act 1984; the authorised sign NP 818.8 or signs incorporating the authorised symbol S 68 may be placed on or near any road for which North Somerset County Council is the traffic authority, in sufficient numbers and in appropriate positions to provide advance indication to all traffic of the Clean Air Zone and the nature of the provisions of a Scheme.



- (3) Without prejudice to any regulations made under paragraph 22 (1) (e) of Schedule 9 to the Road Traffic Regulation Act 1984; the authorised sign NP 894.1 may be placed on or near any road for which North Somerset County Council is the traffic authority, in sufficient numbers and in appropriate positions as a reminder to all traffic within the Clean Air Zone in which cameras are used to enforce traffic regulations.
- (4) Without prejudice to any regulations made under paragraph 22 (1) (e) of Schedule 9 to the Road Traffic Regulation Act 1984; the authorised sign NP 664.4 shall be placed on or near any road for which North Somerset County Council is the traffic authority, in sufficient numbers and in appropriate positions to indicate to all traffic the end of the Clean Air Zone.
- (5) Without prejudice to any regulations made under paragraph 22 (1) (e) of Schedule 9 to the Road Traffic Regulation Act 1984; the authorised sign E shall be placed on or near any road for which North Somerset County Council is the traffic authority, in sufficient numbers and in appropriate positions to indicate to all traffic information pertaining to the introduction of the Clean Air Zone and the nature of the provisions of a Scheme.
- (6) Without prejudice to any regulations made under paragraph 22 (1) (e) of Schedule 9 to the Road Traffic Regulation Act 1984; the direction sign incorporating the authorised symbol S 68 may be placed on or near any road for which North Somerset County Council is the traffic authority, in sufficient numbers and in appropriate positions to provide advance indication to all traffic of the Clean Air Zone and the nature of the provisions of a Scheme.
- (7) The authorised sign NP 677.1, the authorised sign NP 818.8, the authorised sign NP 894.1, the authorised sign NP 664.4, the authorised sign E, the direction sign and the authorised symbol S 68 when incorporated on signs, may be placed only as appropriate to indicate the provisions of a Scheme.



- (8) It is a condition of this authorisation that the authorised sign NP 677.1 and the authorised sign NP 664.4 may only be placed to indicate the effect of an Act, order, regulation, bylaw, resolution or notice which restricts or prohibits the use of the road by traffic; and
- (9) Without prejudice to any statutory provision to the like effect, it is a condition of this authorisation that the placing of the authorised sign NP 677.1, the authorised sign NP 818.8, the authorised sign NP 894.1, the authorised sign NP 664.4, the authorised sign E, the direction sign and signs incorporating the authorised symbol S 68 on or near the said roads shall continue to have effect only until such day as may be appointed by one month's notice given by the Secretary of State in writing to the traffic authority for the removal or alteration of the authorised signs, and on that day the said authorisation shall, without prejudice to the giving of any further authorisation or direction, cease to have effect.

Dated: *30 March 2022*

Signed by authority of the Secretary of State

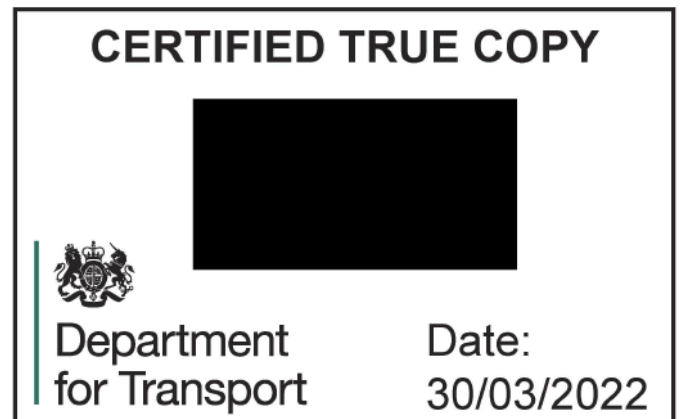
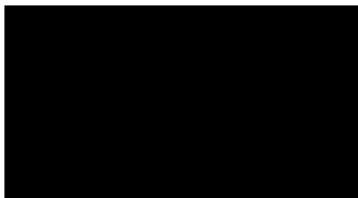

.....

A Delegated Official of the Department for Transport



Before using this drawing, confirm that it has not been superseded.

$\overline{\text{1.5}}$   
  
**Mon - Fri**

 $\overline{\text{1.5}}$   
  
**7 am - 7 pm**

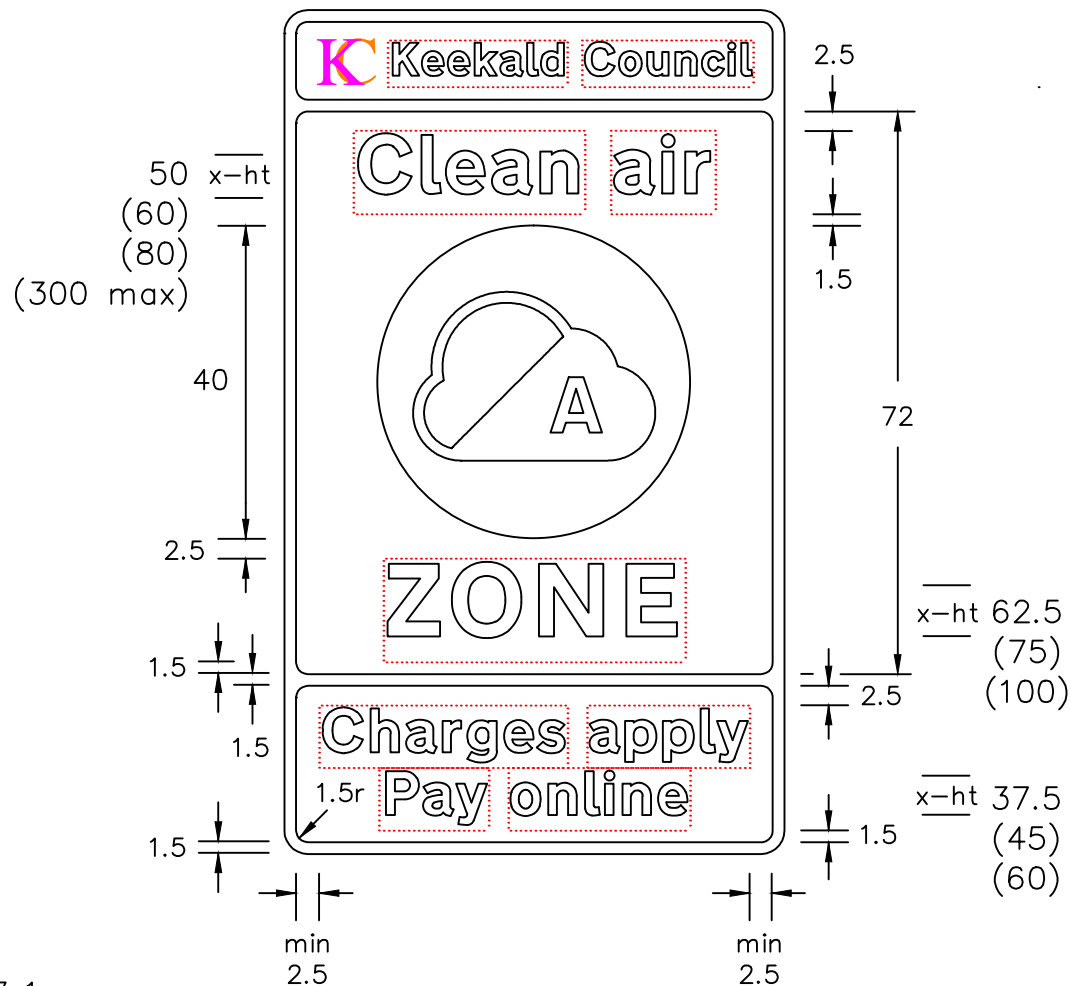

NOTES:

- The legends are from the Transport Heavy alphabet at the x-heights shown.
- Details of the Clean Air Zone (CAZ) symbol are given on drawing S 68.
- The tile outlines do not form part of the sign.
- COLOURS  
 Background ----- WHITE  
 Legends & Border ---- BLACK  
 CAZ Symbol ----- GREEN/WHITE
- DIMENSIONS  
 X-heights are in millimeters, other dimensions are in stroke widths (4sw = x-height).
- All elements on the sign must be increased proportionally in size.

Alternative bottom panel with times

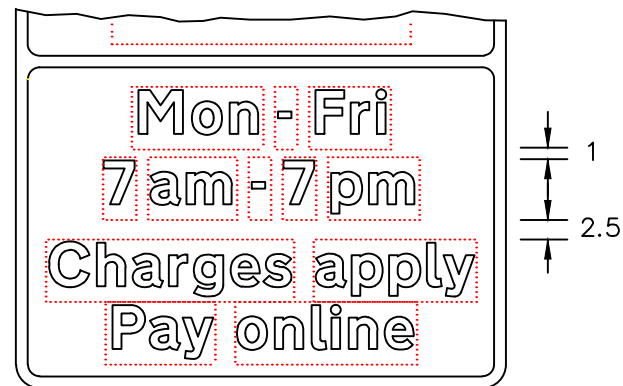

NP677x1

© CROWN COPYRIGHT

 Department for Transport	Title: Regulatory Signs  ENTRANCE TO CLEAN AIR ZONE	Issue:    Date: A:    31.8.18 B:    8.11.19 C:    1.5.20	Drawn by : A.K. Approved by: J.B.	Related drawings :  S 68	Drawing No.  NP 677.1
--	---	---	--	--------------------------------	-----------------------------

**KC** Keekald Council

**Clean air**



**ZONE**

**Charges apply  
Pay online**

**KC** Keekald Council

**Clean air**



**ZONE**

**Mon - Fri  
7 am - 7 pm  
Charges apply  
Pay online**

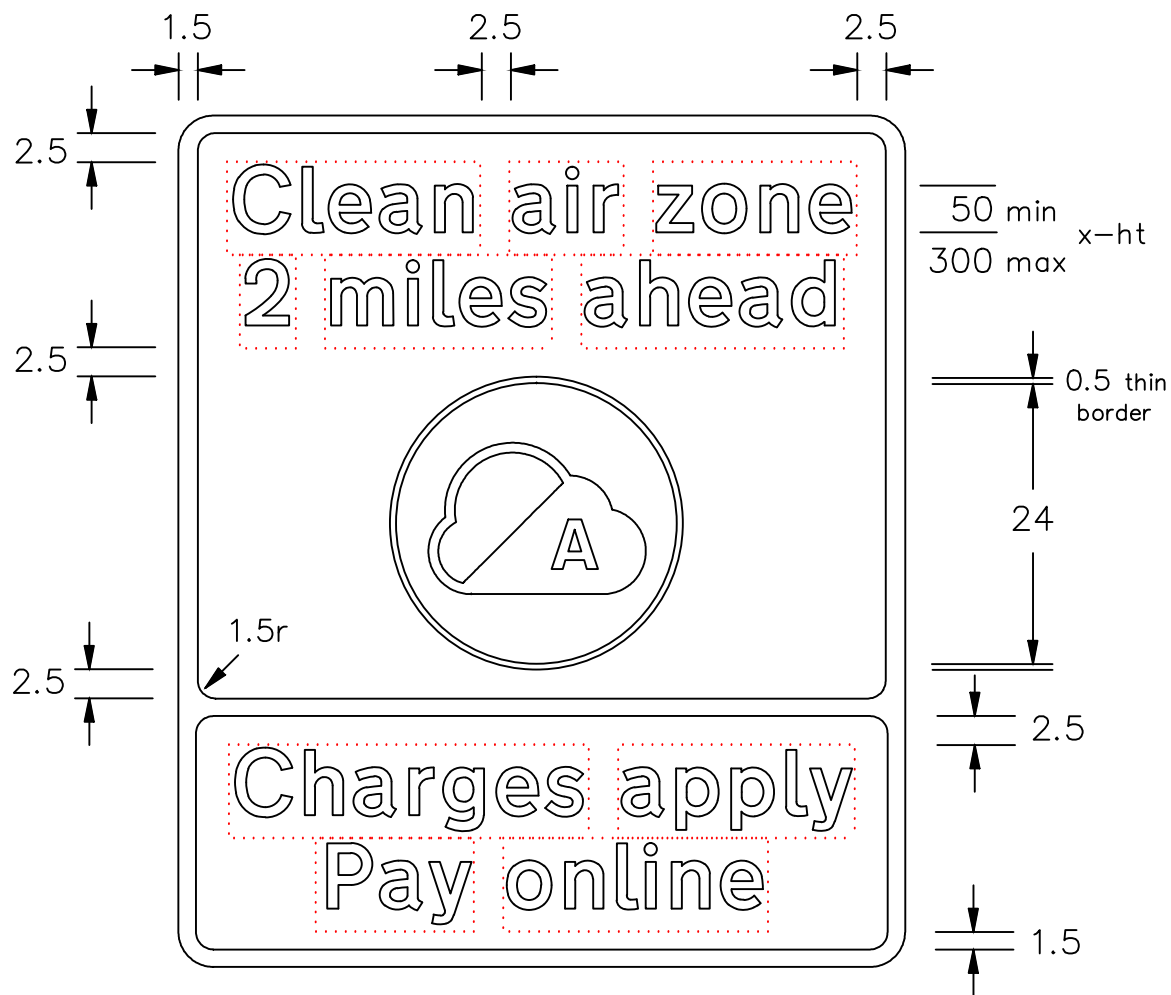

NOTES:

1. The legends are from the Transport Medium alphabet at the x-heights shown.
2. Details of the Clean Air Zone (CAZ) symbol are given on drawing S 68.
3. The tile outlines do not form part of the sign.
4. COLOURS  
 Background -----BLUE  
 Legend & Border ----- WHITE  
 Thin border to CAZ Symbol ----- WHITE  
 CAZ Symbol ----- GREEN/WHITE
5. DIMENSIONS  
 X-heights are in millimeters, other dimensions are in stroke widths (4sw = x-height).
6. See sheet 2 for a variant showing times of operation.

Before using this drawing, confirm that it has not been superseded.

© CROWN COPYRIGHT

NP818x8



Title: Informatory Sign  
 ADVANCE WARNING OF ENTRY  
 INTO A CLEAN AIR ZONE AREA

Issue: Date:  
 A: 31.8.18  
 B: 15.3.22  
 C:

Drawn by :  
 A.K.  
 Approved by:  
 J.B.

Related drawings :  
 S 68

Drawing No.  
 NP 818.8  
 Sheet 1 of 2

x-ht  
 50 min  
 300 max

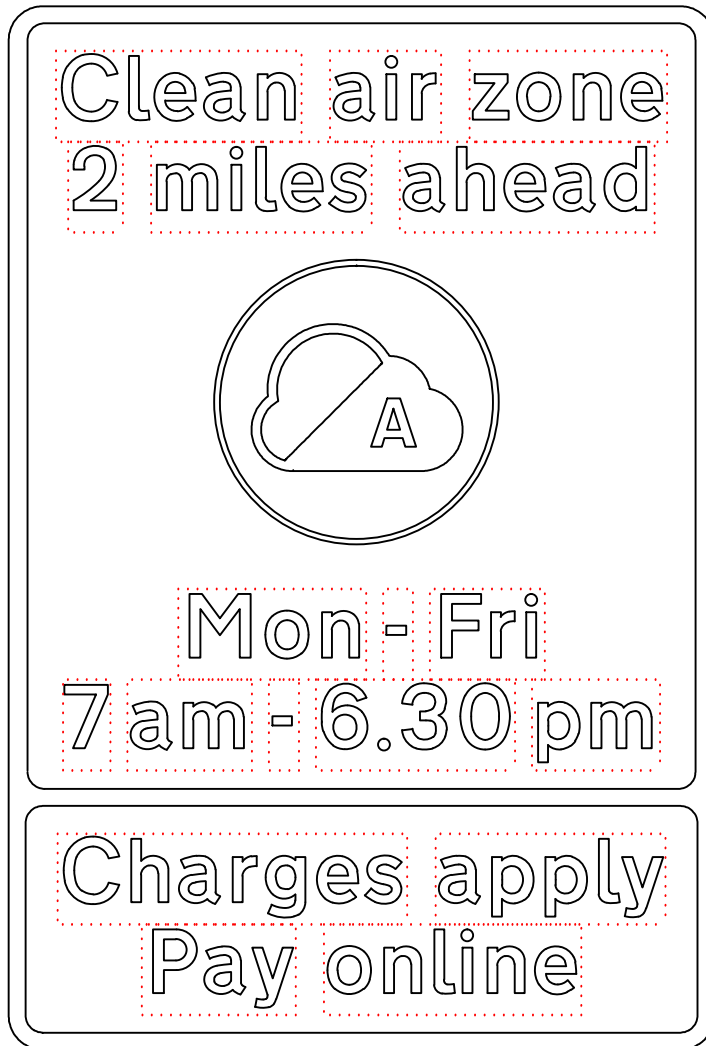

NOTES:

1. The legends are from the Transport Medium alphabet at the x-heights shown.
2. Details of the Clean Air Zone (CAZ) symbol are given on drawing S 68.
3. The tile outlines do not form part of the sign.
4. COLOURS  
 Background ----- BLUE  
 Legend & Border ----- WHITE  
 Thin border to CAZ Symbol ---- WHITE  
 CAZ Symbol ----- GREEN/WHITE
5. DIMENSIONS  
 X-heights are in millimeters, other dimensions are in stroke widths (4sw = x-height).

Before using this drawing, confirm that it has not been superseded.

© CROWN COPYRIGHT

NP818x8

 Department for Transport	Title: Informatory Sign ADVANCE WARNING OF ENTRY INTO A CLEAN AIR ZONE AREA	Issue: A: 31.8.18 B: 15.3.22 C:	Date: A.K. Approved by: J.B.	Related drawings : S 68	Drawing No. NP 818.8 Sheet 2 of 2
---	---	---------------------------------------	---------------------------------	----------------------------	---

**Clean air zone  
2 miles ahead**



**Charges apply  
Pay online**

**Clean air zone  
2 miles ahead**



**Mon - Fri  
7 am - 6.30 pm**

**Charges apply  
Pay online**

**Clean air zone  
2 miles ahead**



**Charges apply  
Pay online**

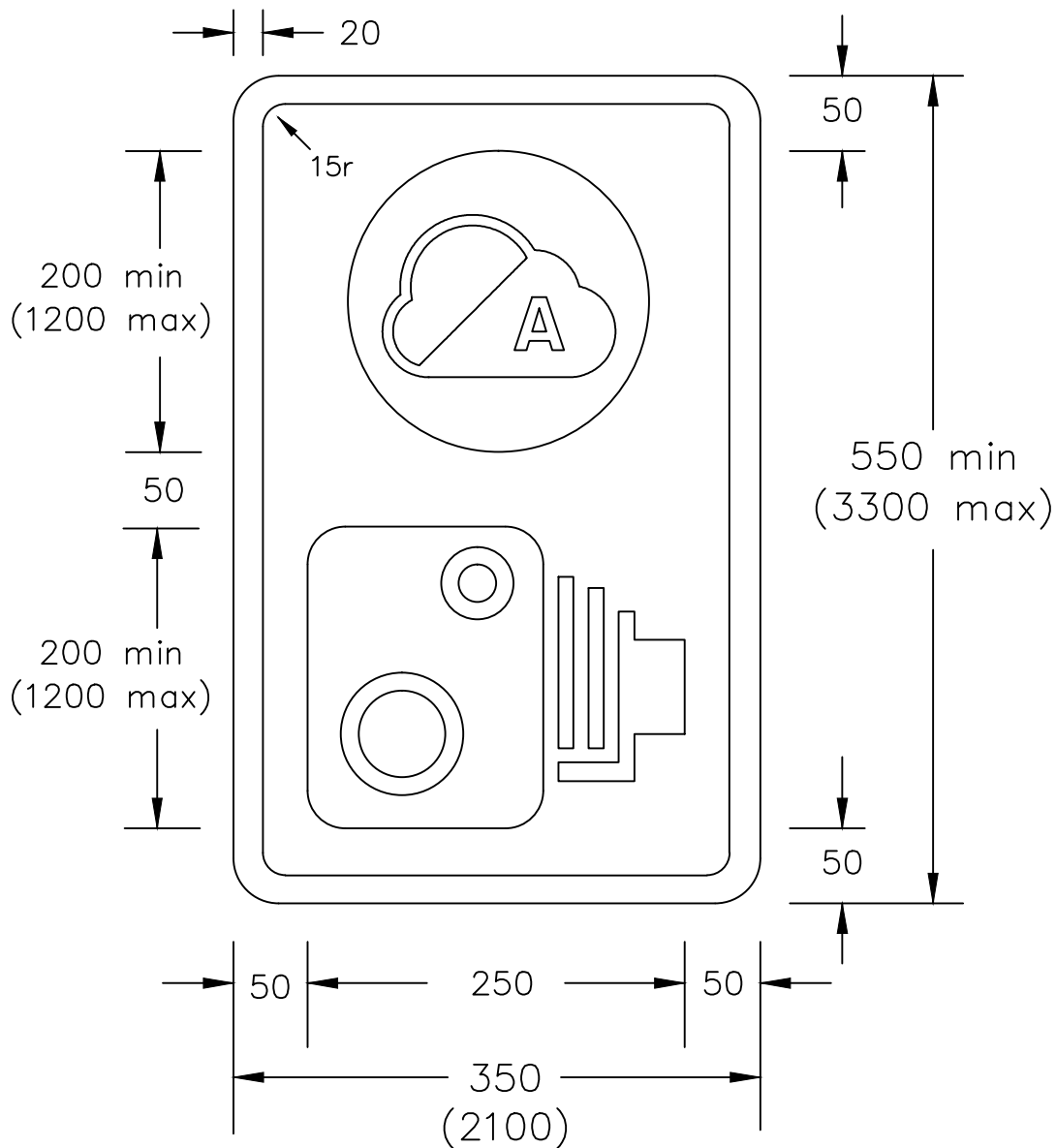

NOTES:

1. Details of the camera symbol are given on drawing S 58.
2. Details of the Clean Air Zone (CAZ) symbol are given on drawing S 68.
3. Dimensions are in millimeters.
4. COLOURS:  
 Background ----- WHITE  
 Border ----- BLACK  
 CAZ Symbol ----- GREEN/WHITE  
 Camera Symbol ----- BLACK
6. All elements on the sign must be increased proportionally in size..

Before using this drawing, confirm that it has not been superseded.

© CROWN COPYRIGHT

NP894x1

	<p>Title: Informatory Sign</p> <p>CAMERA AHEAD AND REMINDER OF CLEAN AIR ZONE</p>	<p>Issue:    Date:</p> <p>A:    31.8.18</p> <p>B:    14.8.19</p> <p>C:    1.5.20</p>	<p>Drawn by : A.K.</p> <p>Approved by: J.B.</p>	<p>Related drawings :</p> <p>S 58, S 68</p>	<p>Drawing No.</p> <p>NP 894.1</p>
--	---	--	---	---	------------------------------------





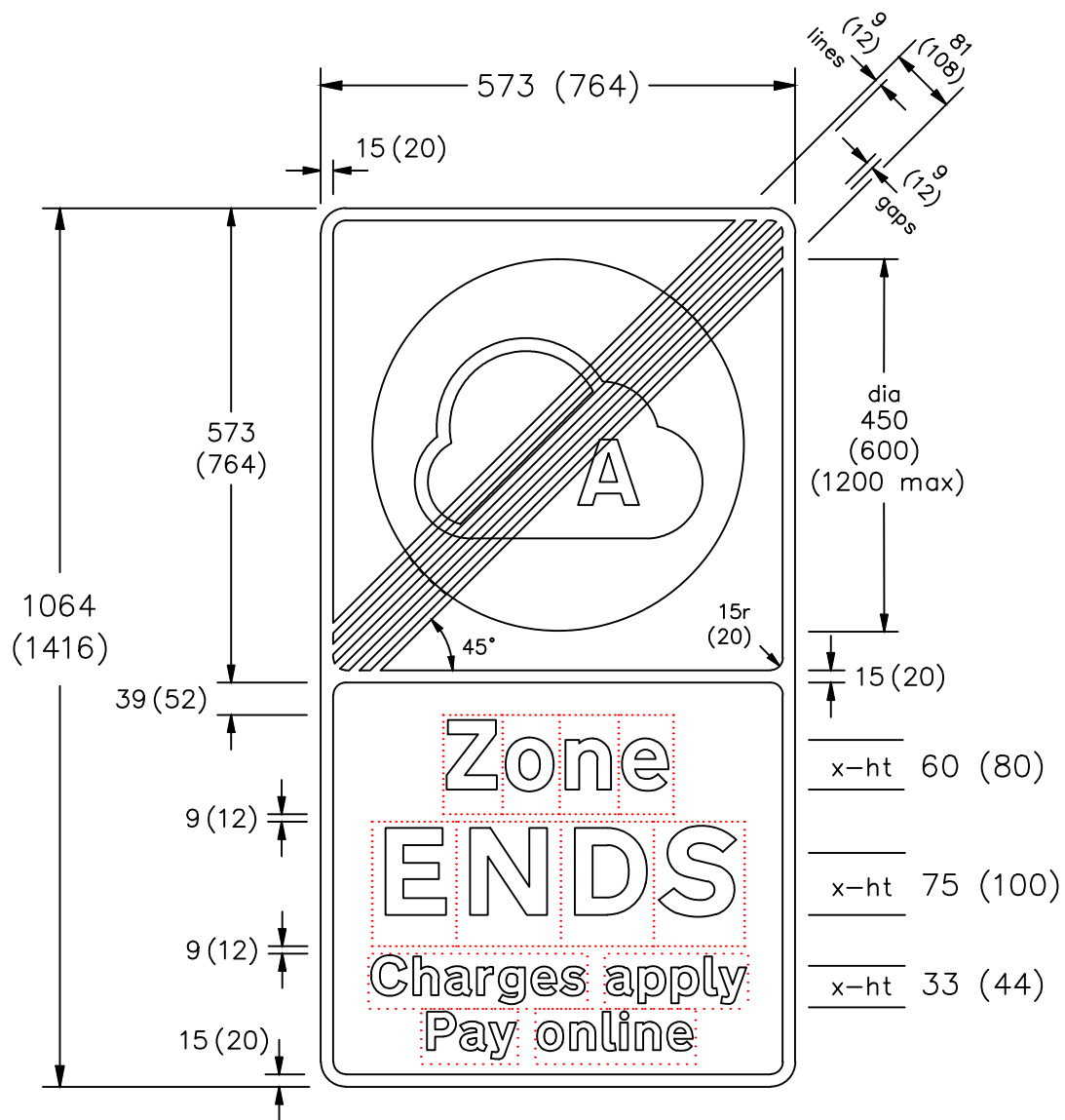

NOTES:

1. The legends are from the Transport Heavy alphabet at the x-heights shown.
2. Details of the Clean Air Zone (CAZ) symbol are given on drawing S 68.
3. The tile outlines do not form part of the sign.
4. COLOURS  
 Backgrounds ----- WHITE  
 Legends, Borders & ----- BLACK  
 Diagonal bars ----- BLACK  
 CAZ Symbol ----- GREEN/WHITE
5. DIMENSIONS  
 All dimensions are in millimeters.
6. All elements on the sign must be increased proportionally in size.

Before using this drawing, confirm that it has not been superseded.

© CROWN COPYRIGHT

NP664x4



Title: Regulatory Sign  
 END OF CLEAN AIR ZONE

Issue: Date:  
 A: 31.8.18  
 B: 1.5.20  
 C:

Drawn by: A.K.  
 Approved by: J.B.

Related drawings: S 68

Drawing No. NP 664.4



**Zone  
ENDS**

**Charges apply  
Pay online**

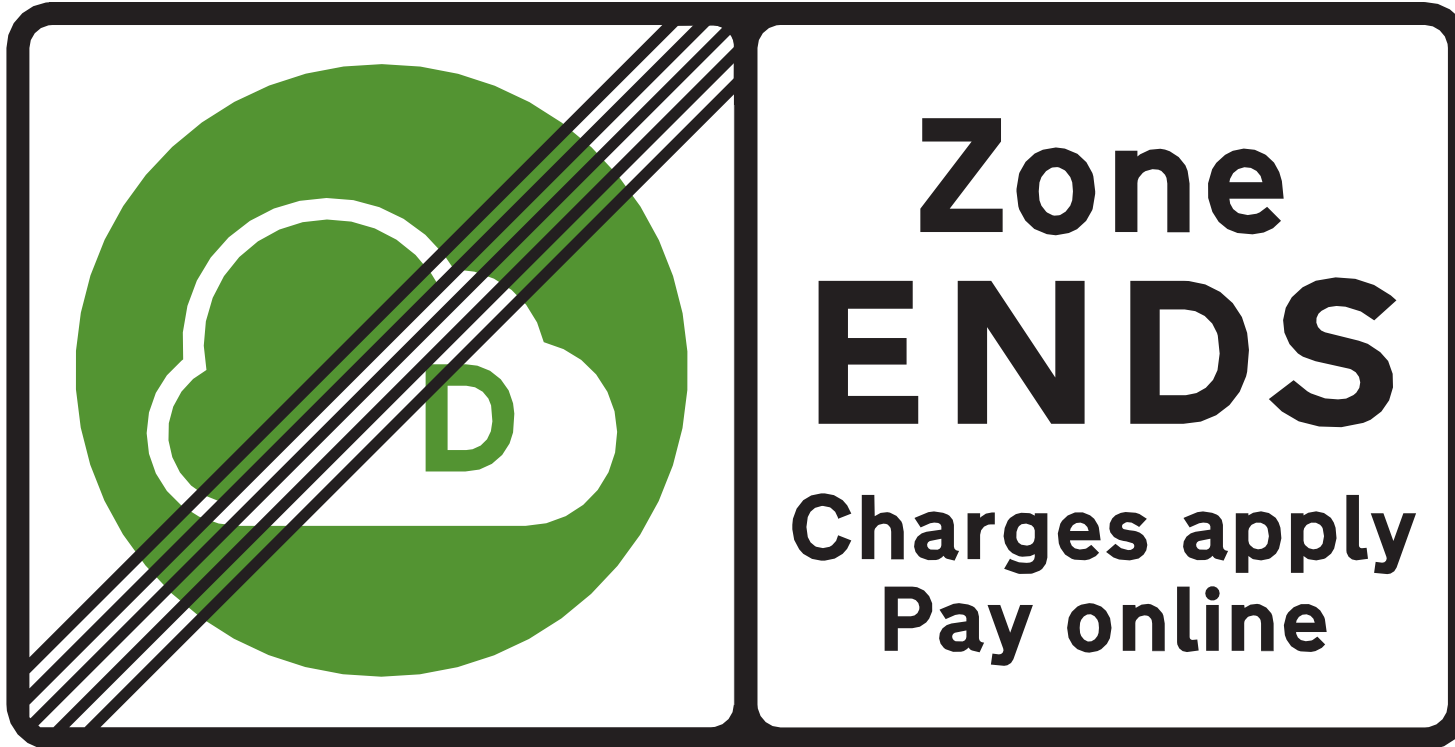

**Zone**  
**ENDS**  
**Charges apply**  
**Pay online**

**KEEKALD  
CLEAN AIR ZONE  
BOUNDARY**

**WILL OPERATE  
AT ALL TIMES  
FROM  
10 JANUARY 2021**

**CHARGES APPLY  
CHECK ONLINE**

**NOTES:**

1. The legend is from the Transport Medium alphabet at the x-heights shown.
2. COLOURS:  
Background ----- RED  
Legend & Border ----- WHITE
3. DIMENSIONS:  
x-heights are in millimetres.

x-ht  
35 min  
400 max



Department  
for Transport

Title:

Temporary Sign

Advance notification pertaining to  
the introduction of a Clean Air Zone

Drawing ref:

**Sign E**

Before using this drawing, confirm that it has not been superseded.

NOTES:

1. The tile outline does not form part of the sign.
2. Dimensions are given in millimeters.
3. The symbol is not reversible.
4. COLOURS:  
Background ----- GREEN  
CAZ Symbol ----- WHITE  
Legend ----- GREEN
5. All elements on the sign must be increased proportionally in size.

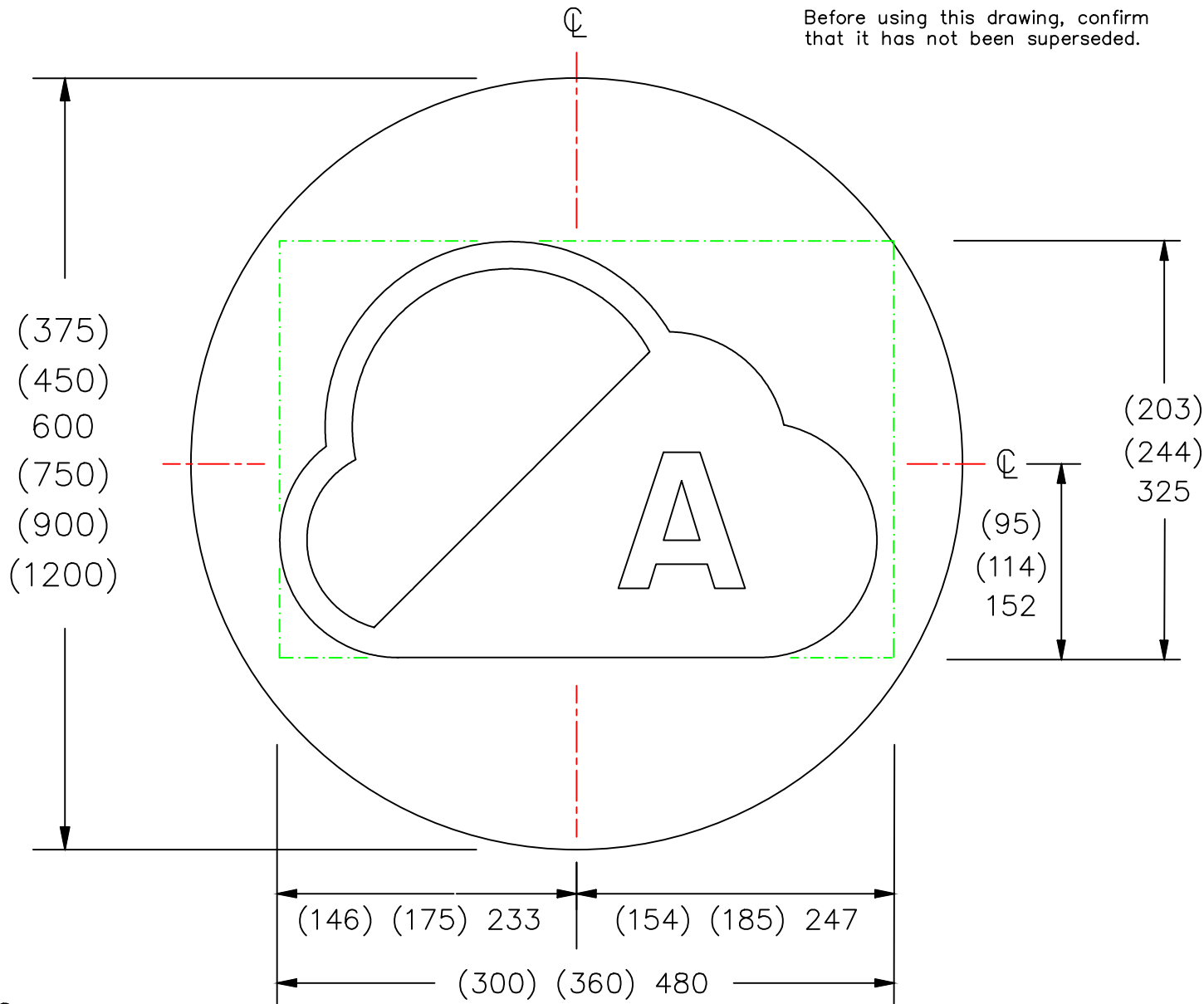

S68

© CROWN COPYRIGHT

 Department for Transport	Title:	Symbol	Issue:	Date:	Drawn by:	Related drawings:	Drawing No.
		CLEAN AIR ZONE	A:	31.8.18	A.K.		S 68 sheet
			B:	22.11.19	Approved by:		1 of 5
			C:	1.5.20	J.B.		

Before using this drawing, confirm that it has not been superseded.

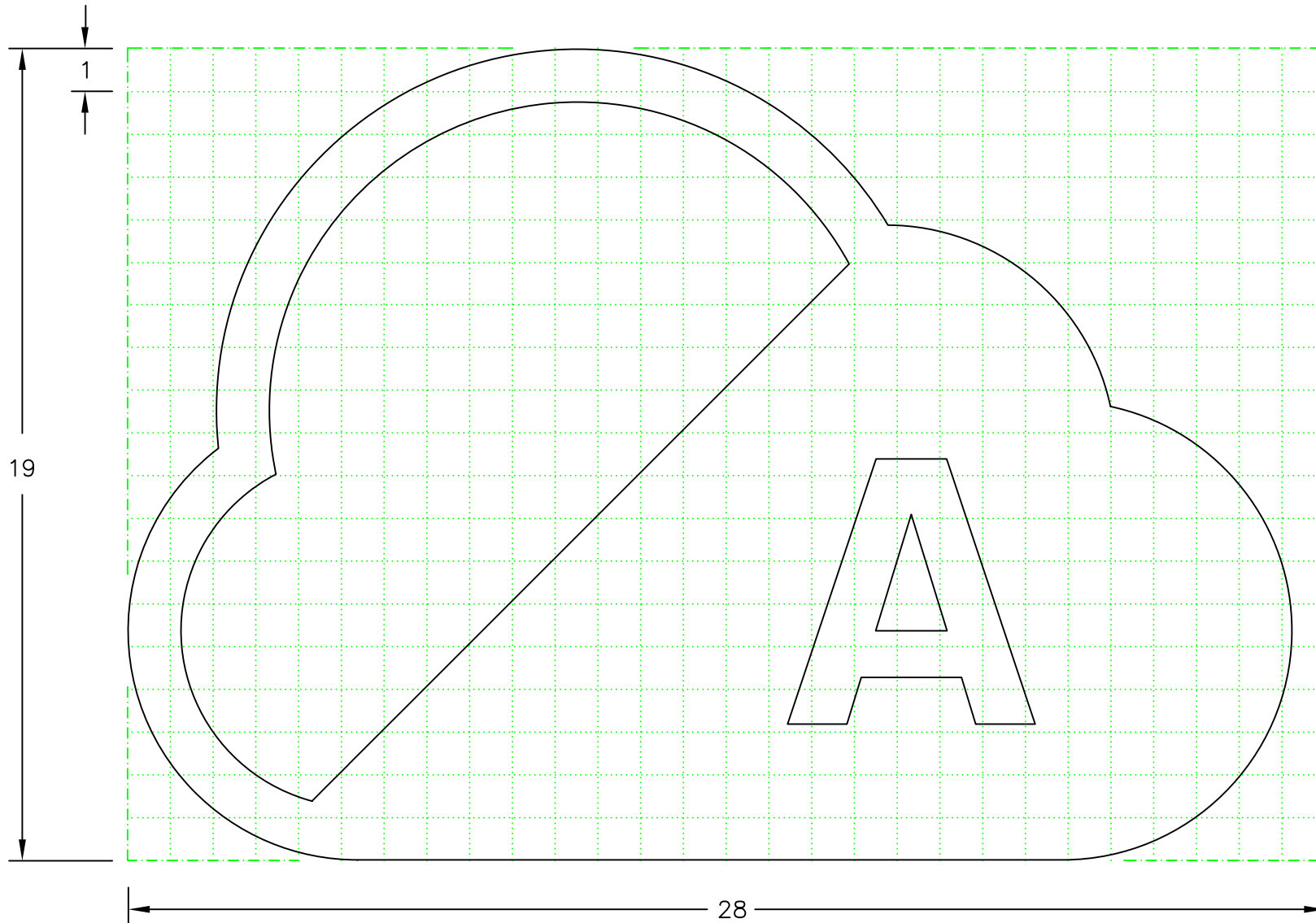

NOTES:

1. The grid does not form part of any sign to which the symbol is applied.
2. Dimensions are given in grid divisions.
3. The symbol is not reversible.
4. The legend is from the Transport Heavy alphabet.

S68

© CROWN COPYRIGHT

 Department for Transport	Title : <p style="text-align: center;">Symbol</p> <p style="text-align: center;">CLEAN AIR ZONE</p>	Issue:    Date : A :        31.8.18 B : C :	Drawn by : A.K. Approved by: J.B.	Related drawings :	Drawing No. <p style="text-align: center;">S 68</p> sheet 2 of 5
---	--	--	--	--------------------	--

Before using this drawing, confirm that it has not been superseded.

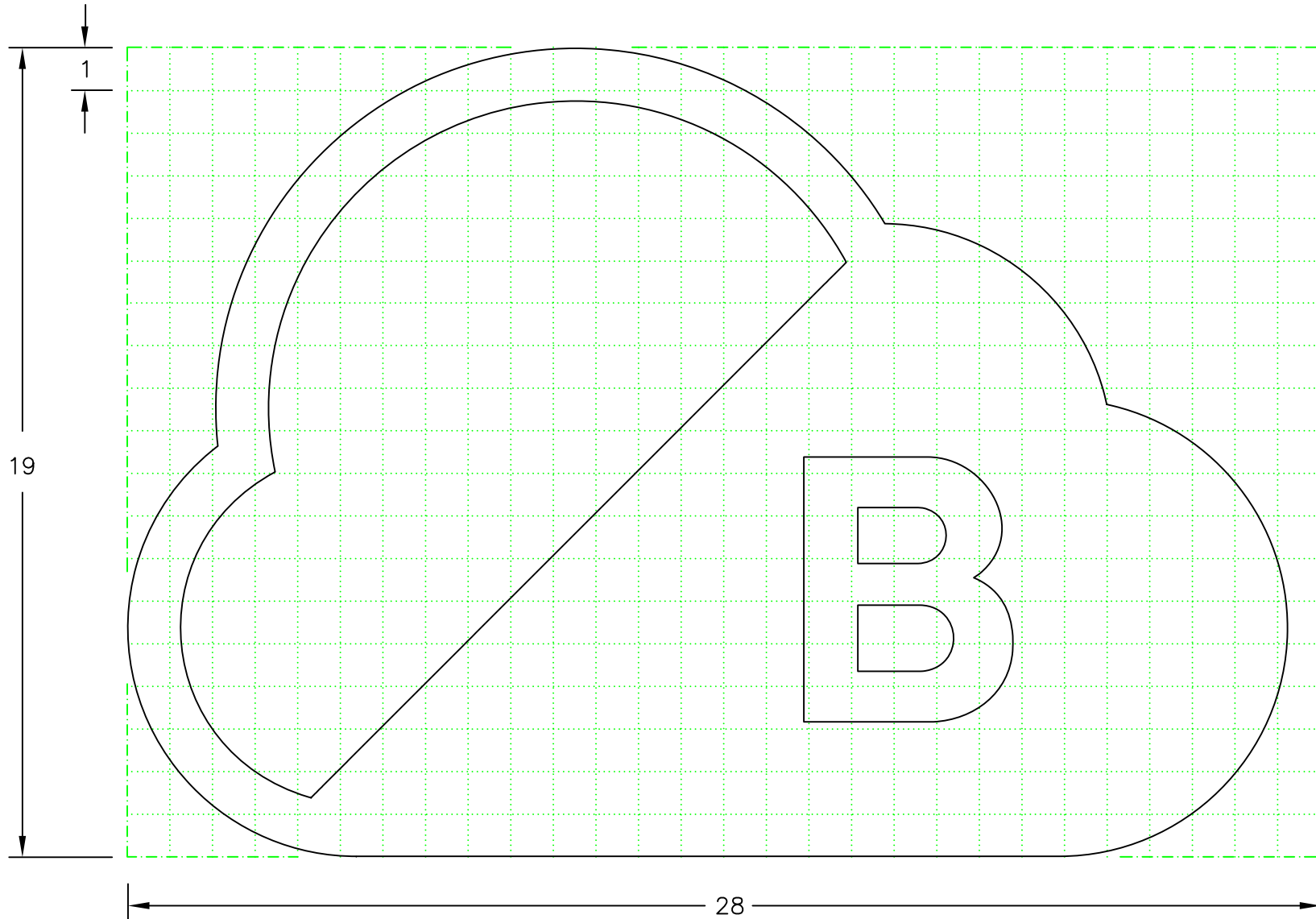

NOTES:

1. The grid does not form part of any sign to which the symbol is applied.
2. Dimensions are given in grid divisions.
3. The symbol is not reversible.
4. The legend is from the Transport Heavy alphabet.

S68

© CROWN COPYRIGHT

 Department for Transport	Title :  Symbol  <b>CLEAN AIR ZONE</b>	Issue : A : B : C :	Date : 31.8.18	Drawn by : A.K. Approved by : J.B.	Related drawings :  Drawing No.  <b>S 68</b> sheet 3 of 5
---	--	------------------------------	-------------------	---	--

Before using this drawing, confirm that it has not been superseded.

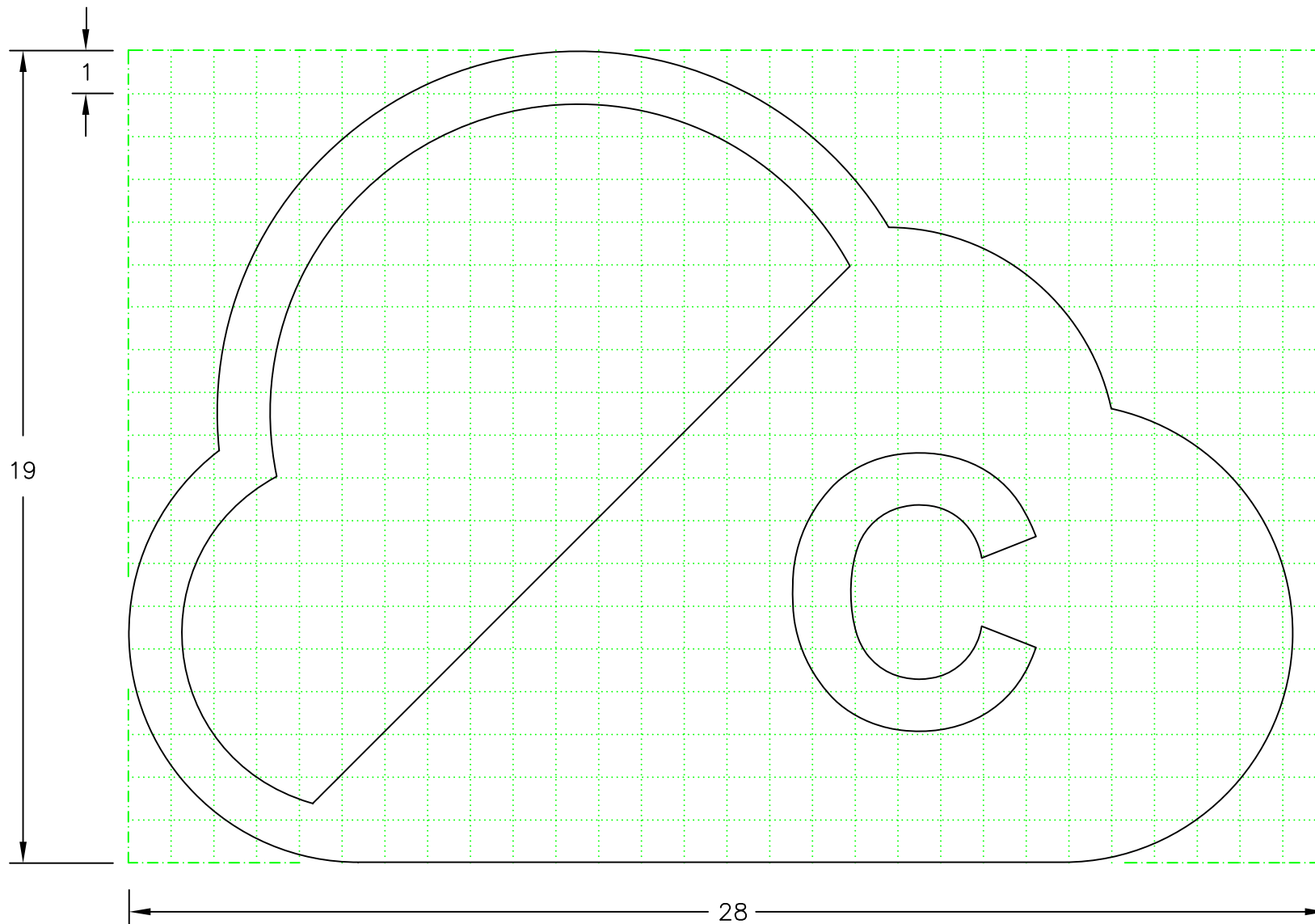

NOTES:

1. The grid does not form part of any sign to which the symbol is applied.
2. Dimensions are given in grid divisions.
3. The symbol is not reversible.
4. The legend is from the Transport Heavy alphabet.

S68

© CROWN COPYRIGHT



Title:

CLEAN AIR ZONE

Symbol

Issue: Date:

A: 31.8.18

B:

C:

Drawn by:

A.K.

Approved by:

J.B.

Related drawings:

Drawing No.

S 68 sheet 4 of 5



Before using this drawing, confirm that it has not been superseded.

NOTES:

1. The grid does not form part of any sign to which the symbol is applied.
2. Dimensions are given in grid divisions.
3. The symbol is not reversible.
4. The legend is from the Transport Heavy alphabet.

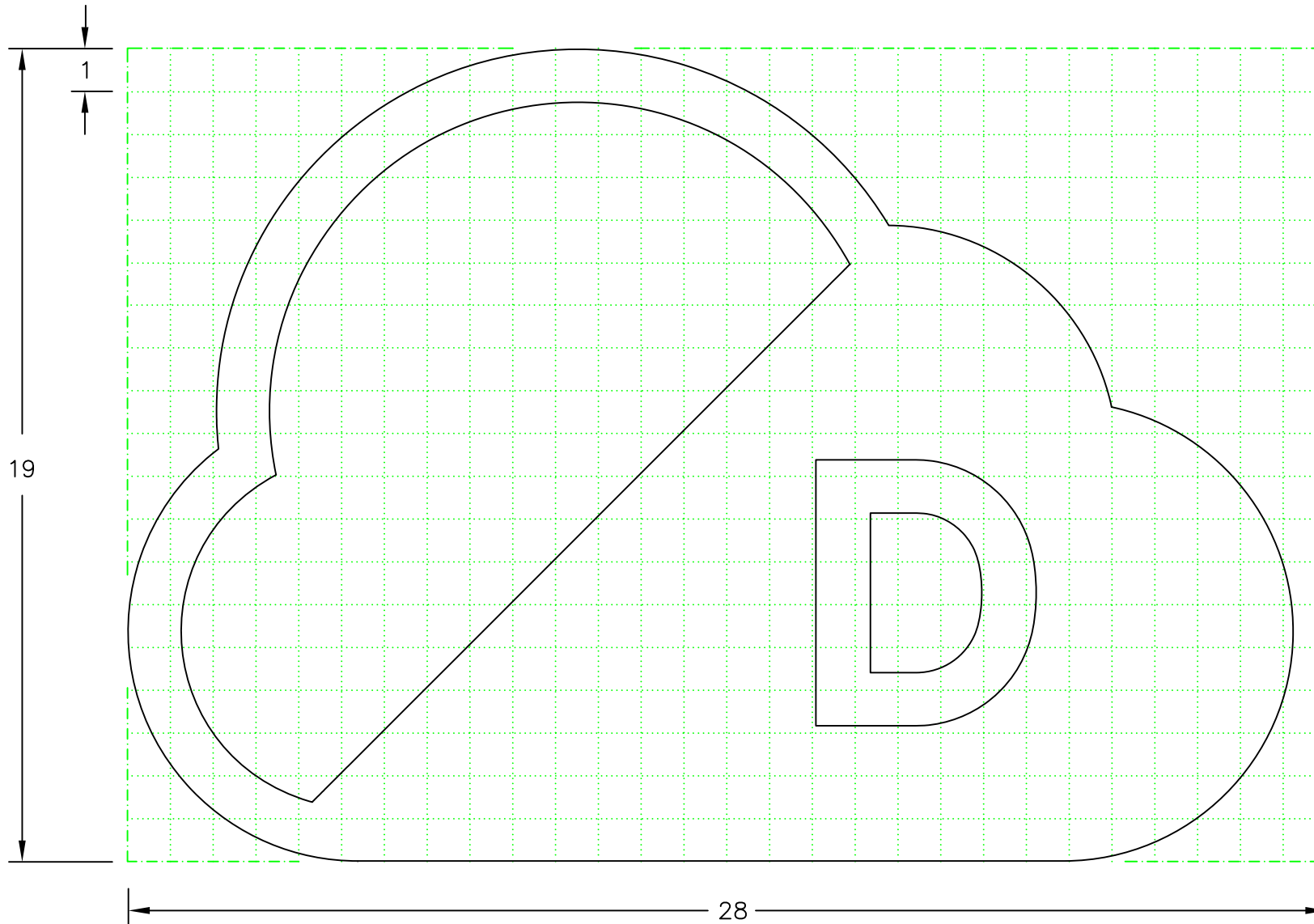

S68

© CROWN COPYRIGHT

 Department for Transport	Title :  Symbol  <b>CLEAN AIR ZONE</b>	Issue : A : B : C :	Date : 31.8.18  Drawn by : A.K. Approved by : J.B.	Related drawings :	Drawing No.  <b>S 68</b> sheet 5 of 5
---	--	------------------------------	--	--------------------	--



