



Department  
for Transport

## Road Traffic Regulation Act 1984 Sections 64 and 65

### Authorisation of traffic signs and special directions

#### Accessible transcript

Secretary of State for Transport's traffic authorisation of traffic signs , for the purpose of informing road users of segregated pedestrian and cyclist crossings on roads for which Transport for London is the traffic authority.

The following pages contain a copy of the text from the Secretary of State for Transport's traffic authorisation regarding the above traffic signs.

A scanned copy of the signed authorisation and supporting documents from the application are appended to this letter. The supporting material is submitted to the Department for Transport by a third party. You should refer to the party involved for accessible copies of the supporting material.



**ROAD TRAFFIC REGULATION ACT 1984 – SECTIONS 64 AND 65  
AUTHORISATION OF TRAFFIC SIGNS AND SPECIAL DIRECTIONS**

The Secretary of State for Transport, in exercise of her powers under Sections 64 and 65 of the Road Traffic Regulation Act 1984, and of all other powers enabling her in that behalf, for the purpose of informing road users of segregated pedestrian and cyclist crossings on roads for which Transport for London is the traffic authority, hereby:-

1. authorises the placing at appropriate sites on the said roads of a traffic sign consisting of a road marking (hereinafter referred to as “the authorised marking”) comprising of zig-zag lines, a pedestrian crossing and a cyclist crossing conforming as to size, colour and character with that shown in the attached drawing numbered NP 1003.6; and
2. directs that the dimensions in column 3 of the road markings shown in diagram 1001.3 (Schedule 14, Part 2, Item 51), diagram 1055.1 (Schedule 14, Part 2, Item 55) and diagram 1055.3 (Schedule 14, Part 2, Item 57) of the Traffic Signs Regulations 2016 (Part 1 of S.I. 2016/362, “the 2016 Regulations”) shall apply in the same manner to the respective road markings that form part of the authorised marking; and
3. directs that the variants in column 4 of the road markings shown in diagram 1001.3 (Schedule 14, Part 2, Item 51), diagram 1055.1 (Schedule 14, Part 2, Item 55) and diagram 1055.3 (Schedule 14, Part 2, Item 57) of the 2016 Regulations shall apply in the same manner to the respective road markings that form part of the authorised marking; and
4. directs that the authorised marking may only be placed at signal controlled segregated pedestrian and cyclist crossings; and
5. directs that the distance between the pedestrian and cyclist crossings on the authorised marking may be varied within the range of 400 millimetres to 4000 millimetres; and



6. directs, without prejudice to any statutory provision to the like effect that it is a condition of this authorisation that the placing of the authorised marking at or near the said sites shall continue to have effect only until such day as may be appointed by one month's notice given by the Secretary of State in writing to the traffic authority for the removal or alteration of the authorised marking and on that day the said authorisation shall, without prejudice to the giving of any further authorisation or direction, cease to have effect.

The provisions of Regulations 7, 9 and 10 of the 2016 Regulations shall apply to the authorised marking in the same manner as they apply to the road markings shown in diagram 1001.3 (Schedule 14, Part 2, Item 51), diagram 1055.1 (Schedule 14, Part 2, Item 55) and diagram 1055.3 (Schedule 14, Part 2, Item 57) of those Regulations.

The provisions of Schedule 14, Parts 1, 4, 5 and 6 of the 2016 Regulations shall apply to the authorised marking in the same manner as they apply to the road markings shown in diagram 1001.3 (Schedule 14, Part 2, Item 51), diagram 1055.1 (Schedule 14, Part 2, Item 55) and diagram 1055.3 (Schedule 14, Part 2, Item 57) of those Regulations.

Dated *15 April 2025*

Signed by authority of the Secretary of State

.....  
A Delegated Official of the Department for Transport



Department  
for Transport

**SCANNED  
AUTHORISATION  
AND SUPPORTING  
DOCUMENTS  
FOLLOW**



**ROAD TRAFFIC REGULATION ACT 1984 – SECTIONS 64 AND 65  
AUTHORISATION OF TRAFFIC SIGNS AND SPECIAL DIRECTIONS**

The Secretary of State for Transport, in exercise of her powers under Sections 64 and 65 of the Road Traffic Regulation Act 1984, and of all other powers enabling her in that behalf, for the purpose of informing road users of segregated pedestrian and cyclist crossings on roads for which Transport for London is the traffic authority, hereby:-

1. authorises the placing at appropriate sites on the said roads of a traffic sign consisting of a road marking (hereinafter referred to as “the authorised marking”) comprising of zig-zag lines, a pedestrian crossing and a cyclist crossing conforming as to size, colour and character with that shown in the attached drawing numbered NP 1003.6; and
2. directs that the dimensions in column 3 of the road markings shown in diagram 1001.3 (Schedule 14, Part 2, Item 51), diagram 1055.1 (Schedule 14, Part 2, Item 55) and diagram 1055.3 (Schedule 14, Part 2, Item 57) of the Traffic Signs Regulations 2016 (Part 1 of S.I. 2016/362, “the 2016 Regulations”) shall apply in the same manner to the respective road markings that form part of the authorised marking; and
3. directs that the variants in column 4 of the road markings shown in diagram 1001.3 (Schedule 14, Part 2, Item 51), diagram 1055.1 (Schedule 14, Part 2, Item 55) and diagram 1055.3 (Schedule 14, Part 2, Item 57) of the 2016 Regulations shall apply in the same manner to the respective road markings that form part of the authorised marking; and
4. directs that the authorised marking may only be placed at signal controlled segregated pedestrian and cyclist crossings; and
5. directs that the distance between the pedestrian and cyclist crossings on the authorised marking may be varied within the range of 400 millimetres to 4000 millimetres; and



6. directs, without prejudice to any statutory provision to the like effect that it is a condition of this authorisation that the placing of the authorised marking at or near the said sites shall continue to have effect only until such day as may be appointed by one month's notice given by the Secretary of State in writing to the traffic authority for the removal or alteration of the authorised marking and on that day the said authorisation shall, without prejudice to the giving of any further authorisation or direction, cease to have effect.

The provisions of Regulations 7, 9 and 10 of the 2016 Regulations shall apply to the authorised marking in the same manner as they apply to the road markings shown in diagram 1001.3 (Schedule 14, Part 2, Item 51), diagram 1055.1 (Schedule 14, Part 2, Item 55) and diagram 1055.3 (Schedule 14, Part 2, Item 57) of those Regulations.

The provisions of Schedule 14, Parts 1, 4, 5 and 6 of the 2016 Regulations shall apply to the authorised marking in the same manner as they apply to the road markings shown in diagram 1001.3 (Schedule 14, Part 2, Item 51), diagram 1055.1 (Schedule 14, Part 2, Item 55) and diagram 1055.3 (Schedule 14, Part 2, Item 57) of those Regulations.

Dated *15 April 2025*

Signed by authority of the Secretary of State

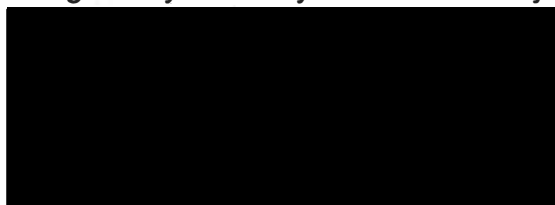

.....  
A Delegated Official of the Department for Transport

**CERTIFIED TRUE COPY**

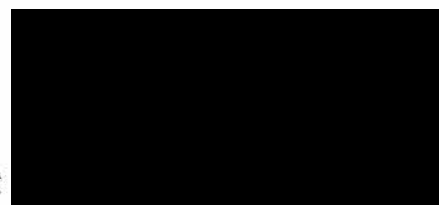

Department  
for Transport

Date:  
16/04/2025

Signal Controlled  
Pedestrian Crossing

Signal Controlled  
Cycle Crossing

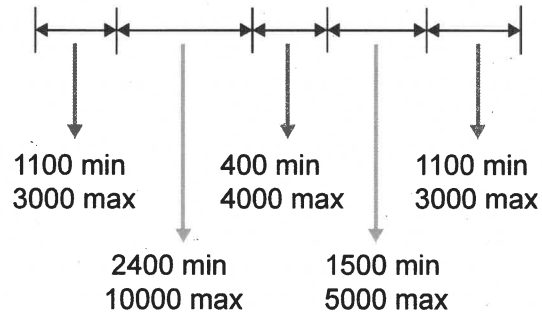
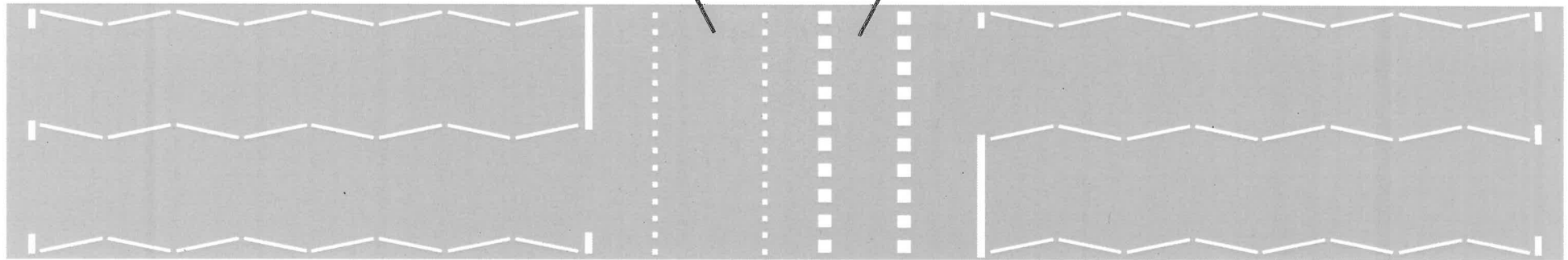

The cycle symbol shown in drawing P 1057 may be included within the signal controlled cycle crossing as appropriate.

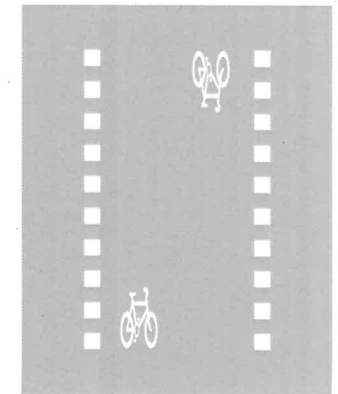
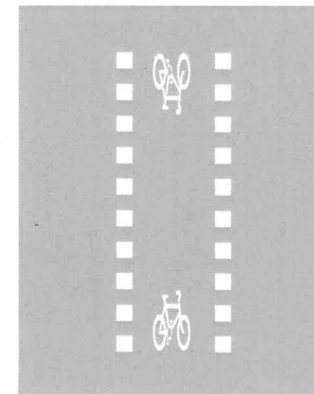

Drawing No.  
P 1057

© CROWN COPYRIGHT

- NOTES: -
1. The marking is based on the cycle symbol shown on drawing S 24 and stretched vertically by a factor of 2.75.
  2. The grid does not form part of the marking.
  3. COLOUR : Cycle Symbol ---- WHITE
  4. The symbol shall be reversed when used with a right turning arrow.

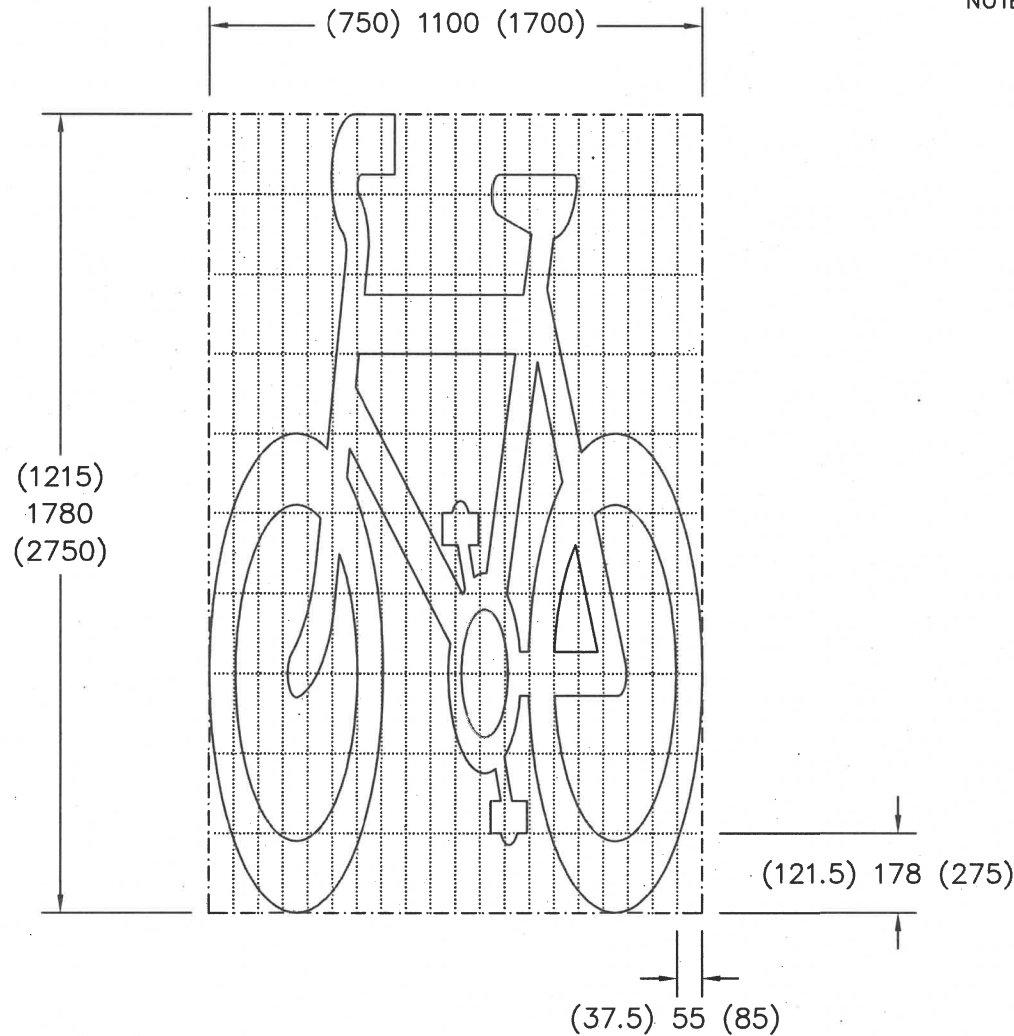

P1057

Before using this drawing, confirm that it has not been superseded.

<b>Department for Transport</b>	Title:  Road Marking <b>CYCLE SYMBOL</b>	Issue:	Date:	Drawn by:	Dimensions:	Drawing No.  <b>P 1057</b>
		A:	30.6.94	S.P.	MILLIMETRES	
		B:	11.7.03	Approved by:		
		C:		R.M.		